

2020 / 2021 CATALOGUE

*Great
Hospitality
Product
Solutions*





WHERE
INNOVATION
创意无止境 HAS NO
BOUNDARYS

The Solution For Any F&B Event

F & B 餐 / 饮 / 管 / 理 / 解 / 决 / 方 / 案

A photograph of a diverse crowd of people gathered on a wooden boardwalk or pier at sunset. The scene is backlit by the warm, golden light of the setting sun, which creates a soft glow and silhouettes the individuals. In the foreground, a man with long dreadlocks is seen in profile, looking towards the right. Next to him, a woman with long blonde hair is also in profile, looking in the same direction. To the right, another woman with long brown hair and sunglasses is visible. The background is filled with many other people, some looking towards the water, others talking or looking away. The overall atmosphere is one of a vibrant, social outdoor event.

INTERNATIONAL
/ CREATIVITY /
INNOVATION

“BEIJING SICO-SST HOSPITALITY EQUIPMENT MANUFACTURING CO., LTD”

GLOBALLY GREAT – WE OPTIMIZE YOUR SPACE

– All our products are available internationally
through our affiliated sales network

OUR MISSION...

- Serving you worldwide with a high quality,
“VALUE FOR MONEY” product
- It is our permanent intention to provide
great innovative products and exceptional
service to you







SPACE USAGE & EFFICIENCY AT ITS BEST

We at SICO-SST are committed to continuously developing high quality and professional products, which helps your operation to serve your customer better

- » F&B EVENT MANGEMENT SOLUTIONS
- » MOBILE BUFFET CONCEPT FROM A-Z
- » MANUFACTURING AT INTERNATIONAL STANDARDS – WCM

With our cutting-edge production & manufacturing assembly lines, combined with advanced technology & International management; we are the right partner for you.

MOBILE BUFFET

布菲理念

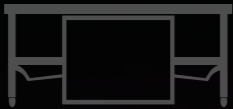

P001-154

1

F&B DELIVERIES

餐饮服务

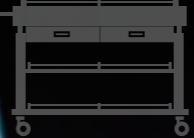

P235-256

3

BQT SOLUTIONS

宴会 / 会议



P155-234

2

LOBBY & GUEST ROOMS

大堂 / 客房

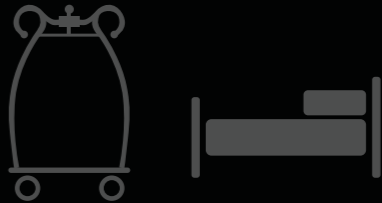

P257-282

4

THE SST-BUFFET WORLD
- WHERE SMALL THINGS MATTER



The Creator Of The Mobile Buffet Concept

MOBILE BUFFET

Table of Contents

Page 03 **BUFFET CONCEPT**
布菲理念

Page 103 **BAR & COCKTAIL**
吧台 & 鸡尾酒桌

Page 135 **DISPLAY & COFFEE CABINETS**
展示架 & 咖啡柜

Page 149 **KID'S CORNER**
儿童乐园

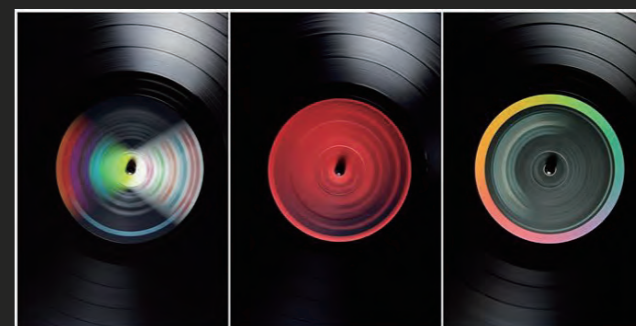

Mobile Buffet Concept

INNOVATIONS

- up to date
- suiting the demands of today's market

Our PROFESSIONAL DESIGNING TEAM

is backed up by a WELL EXPERIENCED ENGINEERING TEAM, locally and as well as internationally.

From the drawing board to finish – all our products are designed with passion and functionality, giving you the tools for a smooth operation.

ENHANCED DINING EXPERIENCE
With the SICO-SST concept it is easy to impress your guests





FLEXIBILITY AT ITS BEST

Efficient - Save Storage Space - Endless Options

Multi-Flex & EVO

Both of this unique modular designs are easy to use and changes can be made in no time.

The setup possibilities are endless and there are many options to choose from.

*** Start small and add-on whenever needed

The System -

Multi-Flex; comes with a folding leg system, which locks in open and closed position

EVO; comes with a center folded understructure and its own casters

Are you looking for the simple straight forward elegant look or want to go more fancy with our customized designer panels and give the station design your own signature.

Storage Space Saving;

* The Multi-Flex design fits 4 complete sets on two designated trolleys (one for the understructure / middle shelf and one or the modules)

* The EVO design due to its special folding structure only takes up 1/3 of the space compared with a regular mobile station

Module flexibility - most of them come in a very slim height, so as they integrate into the top frame. We offer 1/1, 1/2 and 1/4 modules which gives you endless setup possibilities.

Hidden power management - build-in sockets; all cables run inside of the frame and are channeled down the legs.

CARVING STATION

- with Induction Hot Holding



Multi-Flex & EVO



■ EVO Design



UNIQUE MODULAR SYSTEM

■ EVO

■ MULTI-FLEX



■ VARIOUS OPTIONS

Anodized Alu Frame & Rim Colours

Standard

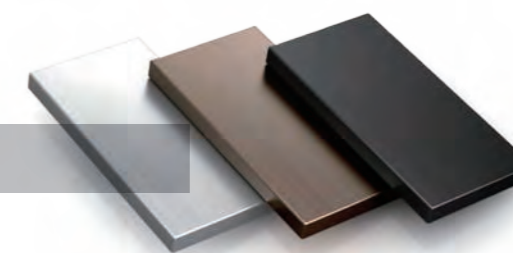

AA01
Silver

AA05
Titanium

AA06
Black

Special

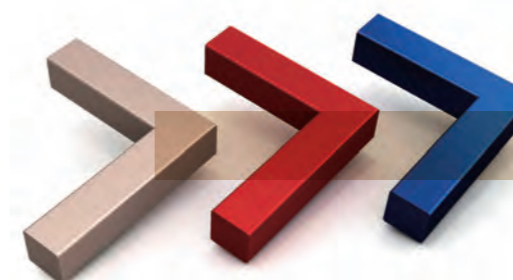

AA07
Rose Gold
(light)

AA08
Red

AA09
Blue

Deluxe Laminate (REV-LAM)



3476H
Jet Sequoia



8830H
Elemental Concrete



0909
Black



3421G
Bianca Luna



9302H
Fantasy Marble



6417H
Elemental Oxide



3423H
Travertine Gold



0909L
Black-Leather

MATCH YOUR INTERIOR DESIGN

With our removable designer panels you can easily give your own signature to the stations and make them match your function rooms. If you are looking for additional sets of theme function panels, they are also available and can be easy interchanged.

*For additional laminate options please contact our customer service.

EVO – THE MOBILE FOLDING MODULAR SYSTEM

EVO 布菲概念 – 移动 / 折叠 / 模块



EVO V3 - Most probably the most efficient modular buffet station currently available on the market. Mobility and flexibility in one specially designed understructure with endless options.



MULTI-FLEX – THE ULTIMATE CONCEPT

欧洲款布菲概念 – 最佳设计理念之一



A steady durable folding leg understructure with modular tops.

Designed to give you the ultimate setup options, interchangeable in no time. Ensuring you are ready for any event.



EVO Setup

- Ideal for in and outdoor functions



EVO – EASY / CONVENIENT / SPACE SAVING
EVO 布菲概念 – 简约 / 便捷 / 节省存储空间

ONE PERSON CAN HANDLE THE EVO STATION EASILY;

- Change the modules without any tools
- MOBILITY; this station rolls in open and folded position on its own casters
- This specially designed folding system is a great space saver
- Save labour – save costs



DELUXE CASTERS

- Durable and silent (German Engineering)



DESIGNED TO SAVE YOU SPACE

Sufficient storage space nowadays is rare, that is why we developed the EVO design; MOBILE FOLDING. All the slim modules can stay in the station in operation as well as storage position. Once folded you can store 3 stations in the space of one fixed station.

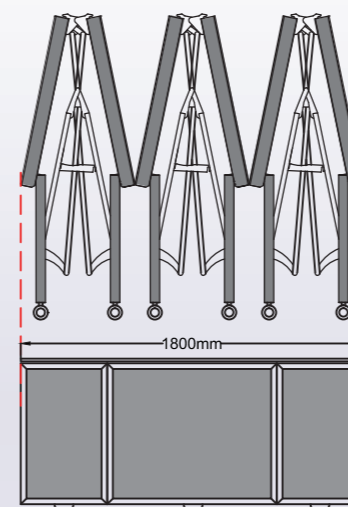
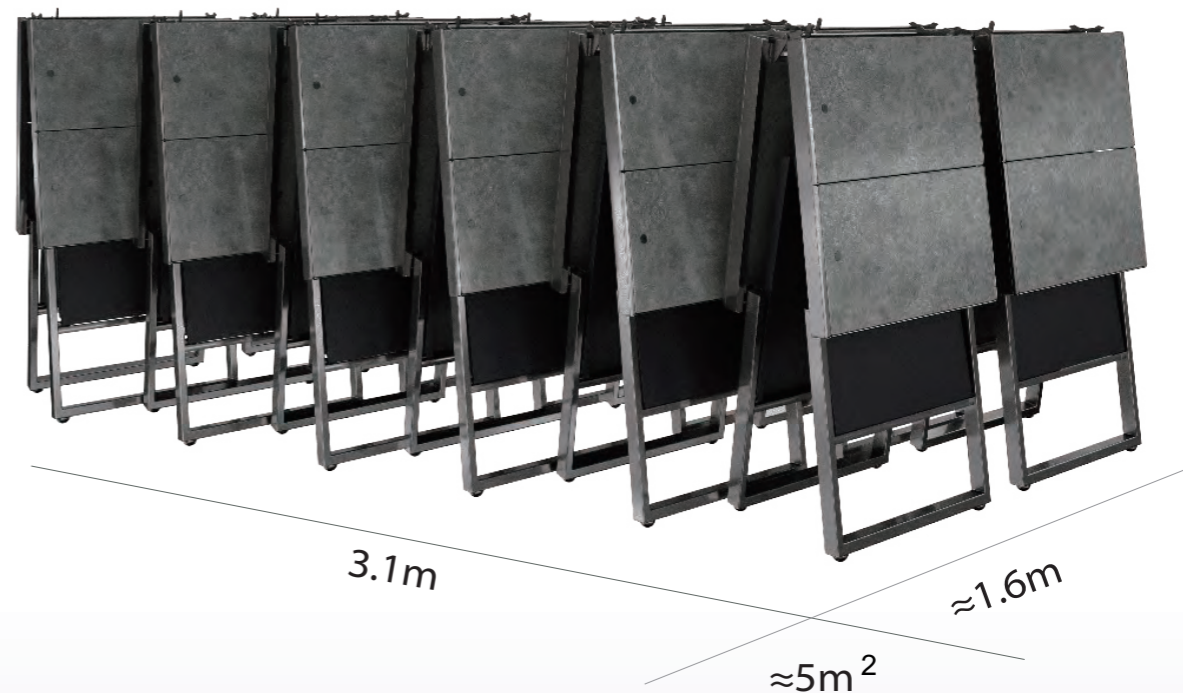

STORAGE

(Efficiency & Space Saving)
Uses only **1/3** of the space compared to the ordinary buffet station

Endless ADD-ONS
侧台



Mobility; this tables can be fitted with optional casters or transported with the designated trolley

They come in matching materials and finishing to suit the main stations; a must for the perfect buffet line, which gives you great layout possibilities.

*** They are available in 3 different heights (850 / 950 / 1050mm), which gives you elevations within the buffet line

*** For additional working & display space, and are great additions to the action stations, as well for individual smaller cocktail setups



Side Stations - 1/2
(Can hold 2x1/4 or 1x1/2 module)

Easy To Hang A Dazzling Color Screen
新发明：一挂即亮挡板

Removable front panel;
aluminum frame with LED or Designer print-on option



***** Alu-Panel Installation**
Simply hang them onto the frame
(no tools are needed)
LED Light starts instantly (Optional)

SPECTACULAR TV-FRONT PANEL

绚丽TV前挡板

We at SICO-SST have developed a frame which can hold a 55" TV Screen, which allows you to change the look of your stations instantly.

*** Your customers can easily upload their Logo, Themes and or whatever they would like to have to fit their particular function

Side Panels

- Standard and Customized Designs are available

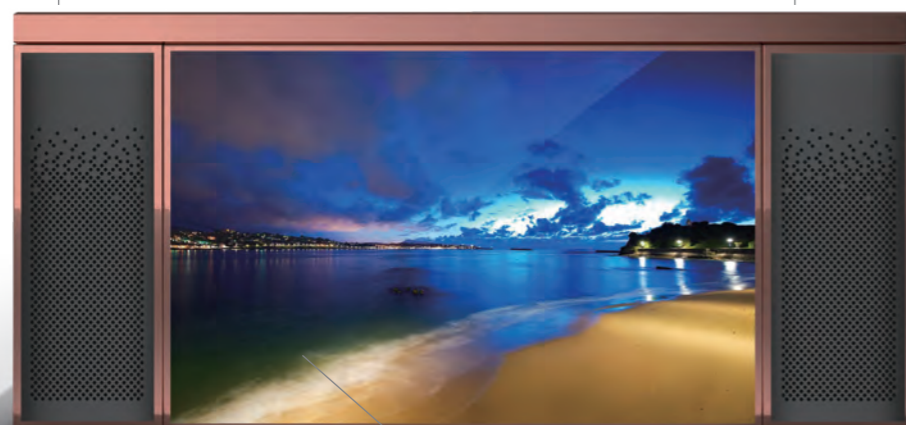

Front Panel

- With Internet TV

RICH INTERFACE, VERSATILE & HANDY

Standard HDMI, USB, AV, Ethernet and other useful interfaces; Let you easily get on the net, upload your own creations. The build-in sound system adds to your atmosphere.



FRONT PANEL - WITH INTERNET TV

FEATURES:

- The high-tech TV is protected by an additional aluminum frame, which at the same time makes it easy to hang-on and remove the panel, no tools are needed
- 4K HDR allows clear picture and movie quality
- High performance; 64 bit quad core processor
- The Internet TV comes with standard apps and you can download additional if needed



<p>4K HDR</p>	<p>Artificial Intelligence</p>	<p>Large capacity RAM</p>
<p>Patchwall</p>	<p>Dolby decoding</p>	<p>Plenty of APP</p>



Designer Panels - Endless Choices
 3种面板组合方式，面板设计风格可以搭配酒店风格自由定制



FRONT & SIDE PANELS



POWER MANAGEMENT



2 pcs outgoing Power Sockets
(15amps)



2 x 2 Universal Power Sockets
(build into the frame)

Modules

模块

Modules – $\frac{1}{4}$

- Induction Hot Holding
- Induction Cooking
- Boiling Unit with four Hole Cover & Baskets
- Boiling Unit with Double Soup Insert
- Boiling Unit with Dim Sum Basket Holder
- Boiling Unit with 1/3 GN Inserts
- Steam Hot Holding
- Induction Wok Cooking (MF only)

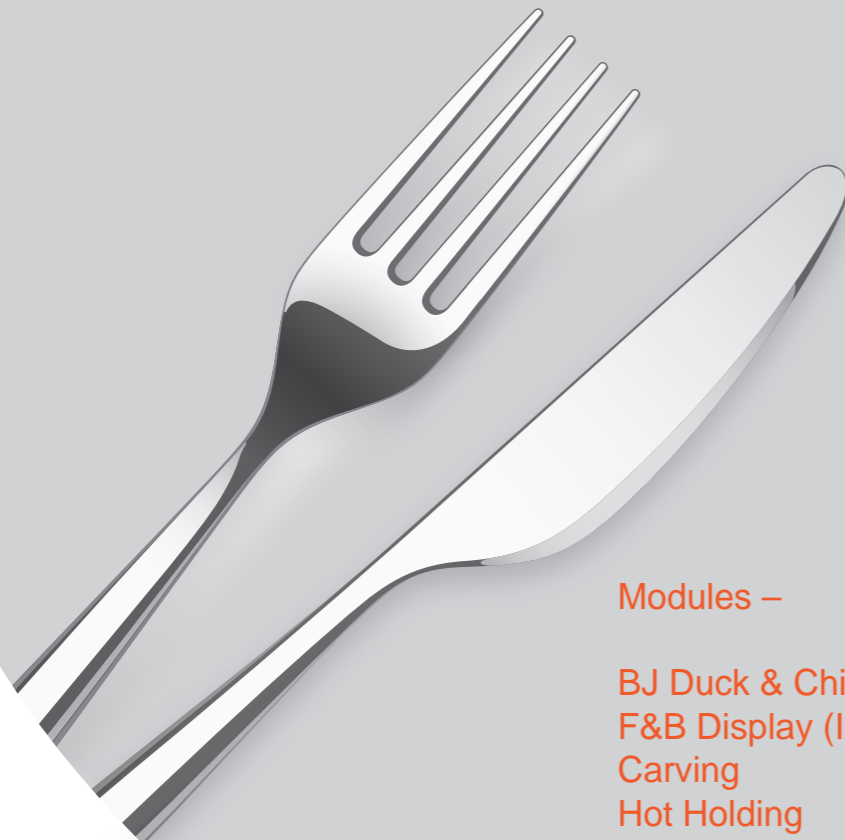

Modules – $\frac{1}{2}$

- BJ Duck & Chinese BBQ
- F&B Display (Ice Well)
- Carving
- Hot Holding
- Hot Plate
- Induction Wok Cooking
- Flat Grill (MF only)

■ ACTION

BJ Duck & Chinese BBQ

With removable stainless steel rack

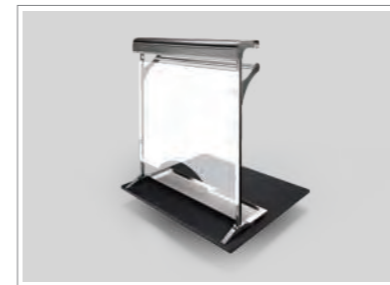

$\frac{1}{2}$
Unit

IDEAL FOR

ROAST & BBQ MEAT PRESENTATION,
COLD CUT & HAM SERVING

FEATURES

- » 18mm MDF Core with both sides Laminate finish
- » Stainless Steel Rack with Sneeze Guard, Hanging Bar & Spot Lighting
- » Removable Drip Tray (S/S)

TECHNICAL SPECIFICATIONS

- » 24W
- » AC220V
- » Plug 10A/AC220V

Grill Plate

(Electric)



$\frac{1}{2}$
Unit

No Humidity

Electric

IDEAL FOR

A LA MINUTE COOKING OF
PORTIONED FOOD

FEATURES

- » 18mm MDF Core with both sides Laminate finish
- » Tempered glass top (two individual cooking zones)
- » Integrated touch control panel
- » Excess liquid collector

TECHNICAL SPECIFICATIONS

- » 4000W
- » AC220V
- » Plug 2x10A/AC220V

Carving

with Heating Lamps



$\frac{1}{2}$
Unit

Electric

IDEAL FOR

PRESENTATION & SERVING OF
ANY TYPE OF HOT CARVING OF MEAT
& SEAFOOD

FEATURES

- » 18mm MDF Core with both sides Laminate finish
- » Stainless Steel Stand with White Plastic Cutting Board
- » Two Stainless Steel Heating Lamps (Table Top Version)

TECHNICAL SPECIFICATIONS

- » 550W
- » AC220V
- » Plug 10A/AC220V

Wok

(Induction)

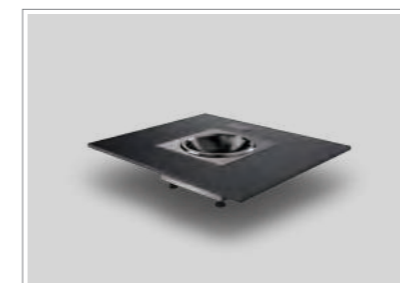

$\frac{1}{4}$
Unit

$\frac{1}{2}$
Unit

Induction

IDEAL FOR

ASIAN STIR-FRIED DISHES

FEATURES

- » 18mm MDF Core with both sides Laminate finish
- » Drop-in Induction Wok with user-friendly Temperature Control (Wok Pan not included)

TECHNICAL SPECIFICATIONS

- » 3500W
- » AC220V
- » Plug 16A/AC220V

Boiling

with 4 Baskets



$\frac{1}{4}$
Unit

Electric

High Humidity

IDEAL FOR

PASTA, DUMPLINGS AND VEGETABLES

FEATURES

- » 18mm MDF Core with both sides Laminate finish
- » Heavy-duty Boiler Unit with user-friendly Temperature Control
- » Uniform temperature distribution
- » Removable Stainless Steel Cover with 4 Holes & Baskets

TECHNICAL SPECIFICATIONS

- » 3200W
- » AC220V
- » Plug 16A/AC220V

Cooking – Deluxe

(Induction)



$\frac{1}{4}$
Unit

Induction

IDEAL FOR

A LA MINUTE COOKING OF
PORTIONED FOOD

FEATURES

- » Tempered Glass Top (Black), with Designer S/S decoration
- » Aluminum Protection Frame (Black anodized)
- » Build in Induction Cooking Plate (50-240°C) with 5 level temperature control (1-5)

TECHNICAL SPECIFICATIONS

- » 1800W
- » AC220V
- » Plug 10A/AC220V

■ ■ HOT HOLDING

Hot Holding – Boiling Unit with GN1/3 Food Pans



1/4 Unit
High Humidity
Electric

IDEAL FOR

HOT SAUCES, STEWS AND WET MAIN DISHES

FEATURES

- » 18mm MDF Core with both sides Laminate finish
- » GN1/1 Boiler with user-friendly Temperature Control
- » Uniform temperature distribution
- » Removable Stainless Steel GN1/3 Food Pans with Cover (3pcs)

TECHNICAL SPECIFICATIONS

- » 2000W
- » AC220V
- » Plug 10A/AC220V

Hot Holding – Boiling Unit with Soup Inserts



1/4 Unit
High Humidity
Electric

IDEAL FOR

SOUPS, CONGEE & LIQUID DESSERTS

FEATURES

- » 18mm MDF Core with both sides Laminate finish
- » GN1/1 Boiler with user-friendly Temperature Control
- » Uniform temperature distribution
- » Removable Stainless Steel Cover with two Soup Inserts

TECHNICAL SPECIFICATIONS

- » 2000W
- » AC220V
- » Plug 10A/AC220V

Hot Holding - Boiling Unit with Dim Sum Basket Holder



1/4 Unit
High Humidity
Electric

IDEAL FOR

STEAMED HOT HOLDING

FEATURES

- » 18mm MDF Core with both sides Laminate finish
- » GN1/1 Boiler with user-friendly Temperature Control
- » Uniform temperature distribution
- » Removable Stainless Steel Tray (perforated), holds 6 towers of baskets (Dia.140mm) or can be customized

TECHNICAL SPECIFICATIONS

- » 2000W
- » AC220V
- » Plug 10A/AC220V

Hot Holding with Electric Plate with Heating Lamps



1/2 Unit
No Humidity
Electric

IDEAL FOR

BREAD & BAKERIES, PIZZA, WARM DESSERTS, DRY SNACKS & PLATED DISHES

FEATURES

- » 18mm MDF Core with both sides Laminate finish
- » Electric Heating Plate (470x620mm)(build-in) with tempered Glass Top, adjustable Temperature Control (up to 85°C)
- » Two Stainless Steel Heating Lamps (Table Top Version)

TECHNICAL SPECIFICATIONS

- » 1180W
- » AC220V
- » Plug 10A/AC220V

■ ■ COLD DISPLAY

Cold F&B Display (Ice Well)

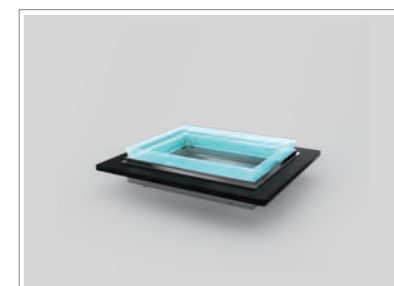

1/2 Unit

IDEAL FOR

SEAFOOD & SALAD BAR / SUSHI & SASHIMI / WINE & CHAMPAGNE BAR

FEATURES

- » 18mm MDF Core with both sides Laminate finish
- » Acrylic Rim & Insert
- » Drainage system with Faucet
- » LED Lighting System (Blue)

TECHNICAL SPECIFICATIONS

- » 80W
- » AC220V
- » Plug 10A/AC220V

Steam Hot Holding with electric Bain-Marie

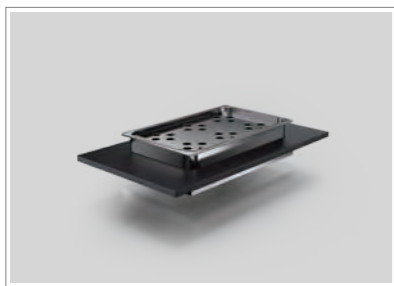

1/4 Unit
High Humidity
Electric

IDEAL FOR

HOT HOLDING OF STEAMED FOOD

FEATURES

- » 18mm MDF Core with both sides Laminate finish
- » GN1/1 Water Pan with Electric Heating Plate
- » Removable Stainless Steel Tray (perforated), holds 6 towers of baskets (Dia.140mm) or can be customized

TECHNICAL SPECIFICATIONS

- » 700W
- » AC220V
- » Plug 10A/AC220V

Hot Holding (Induction)



1/4 Unit
1/2 Unit
Induction

IDEAL FOR

CHAFING DISH (Round or Square), OR ANY INDUCTION FRIENDLY FOOD PAN & CONTAINER

FEATURES

- » 18mm MDF Core with both sides Laminate finish
- » Build in Induction Holding Plate (65-90°C) with 3 level temperature control (1-3)

TECHNICAL SPECIFICATIONS

- » 600W
- » AC220V
- » Plug 10A/AC220V

Ambient Hot Holding with Heating Lamps



1/2 Unit
No Humidity
Electric

IDEAL FOR

BAKED & DEEP-FRIED DISHES

FEATURES

- » 18mm MDF Core with both sides Laminate finish
- » Two Stainless Steel Heating Lamps (Table Top Version)

TECHNICAL SPECIFICATIONS

- » 550W
- » AC220V
- » Plug 10A/AC220V



Accessories

配件

Order our Multi-Purpose Station and create different setups with our wide range of accessories to fit your daily function requirements.

LET US KNOW ANY ADDITIONAL SETUPS YOU WOULD LIKE TO CREATE AND WE WILL COME UP WITH A SOLUTION

Splash Guard (Table Top Version)



IDEAL FOR

SHIELDING YOUR CUSTOMERS FROM POSSIBLE SPLASHES DURING SHOW COOKING

Cutting Board (Rectangular, with Drip Groove)



IDEAL FOR

ROAST & BBQ MEAT PRESENTATION
COLD CUT & HAM SERVING

Buffet Lamp (Table Top Version)



IDEAL FOR

HOT HOLDING: WITH HEATING LAMPS
COLD DISPLAYS: WITH SPOT LIGHTING

Sushi Fridge



IDEAL FOR

SUSHI & SASHIMI DISPLAYS



SNEEZE GUARDS – Table Top Versions

防鼻息罩

- WITH LED LIGHTING SYSTEM; Ideal for cold food displays
- WITH HOT LIGHTING SYSTEM; Ideal for hot holding food displays



Sneeze Guard (small)



Sneeze Guard (large)



Cold Food Setup with Sneeze Guard (LED lighting)

COMBINATION OF EVO BUFFET STATIONS

Cold Setup with Ice Well and Sneeze Guard with Spot Lighting
冰盆加带灯防鼻息罩组合

Spot Light or Heating Lamp (Table Top Version)
聚光灯 / 加热灯 (桌面放置)

Induction Cooking Station with Display & Condiments
感应蒸煮炉带展示和调味品



FEATURES

- 2pcs Main Stations
- 1pc Side Station
- 1pc Sneeze Guard
- 1pc Splash Guard
- 2pcs LED Front Panels
- 1pc Spot Light

LED Front Panel with Designer Print-on
LED发光前挡板设计

LED Front Panel with Designer Print-on
LED发光前挡板设计

Exhaust System - Mobile / Free Standing

移动独立排风机



Exhaust System
(In Front of Station)

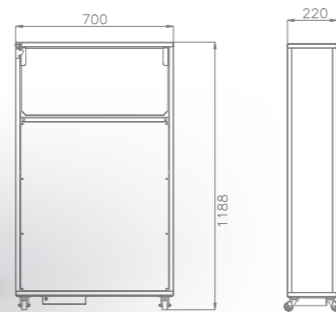

Extension Glass Panel
(folds down for storage)

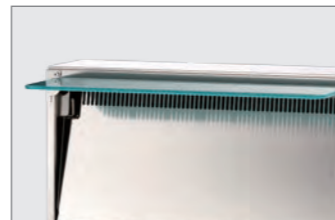

Stainless Steel (Brushed) Front Part for easy cleaning

Laminated Panel with Aluminum Frame (Match your Buffet Station Design)

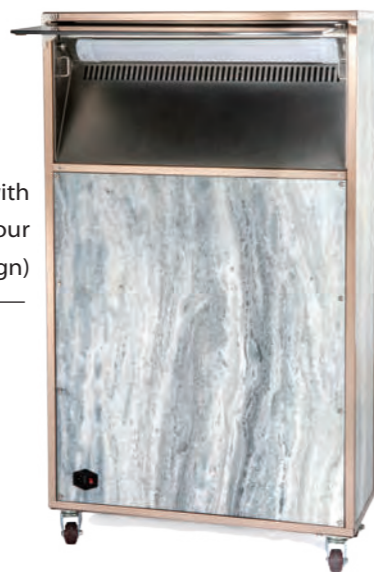

Rolls on its own casters
- easy to put in and out of action

Exhaust System
(Front View)

Multi-Purpose

- Bar / Reception / Sales or Info Counter

多功能吧台

High pressure laminate panels with a stylish aluminum protection edge (anodized).

- Top folds for easy storage
- Two front casters make it easy to relocate



Special Feature;

- Designed for multi-purpose use, suitable for EVO and Multi-Flex Stations.
- The front leg support enhances the bar feeling



One Multi-Purpose Station combined with two Bar/Reception Front Modules





MOBILE / FOLDING DISPLAY BACK WALL

移动/折叠展示背景屏风

THIS IS THE IDEAL BACK GROUND DISPLAY FOR YOUR BUFFET LINE, CREATE YOUR OWN THEME AND MOOD OF THE EVENT.

With the vast choice of accessories your setup options are endless; making a kitchen or grocery wall, bakery or deli shop, or use it as back bar display and so on...



GRANDMA'S KITCHEN BACK WALL DISPLAY



FEATURES;

- 1pc Mobile / Folding Partition (3panels)
- 3pcs Hanging Bars
- 2pcs Shelves (straight-up)
- 2pcs Shelves (slanted)
- 1pc Doughnut Holder Rack
- 6pcs Single Ring Holders (for bowls, plates, pots etc)

FOLDING THREE PANEL DESIGN 三折扇设计

*** For easy moving and taking less space for storage



HIGH PRESSURE LAMINATED PANELS ALLOW YOU TO CHOOSE THE COLOUR AND PATTERN SUITING YOUR INTERIOR DESIGN.

***Optional lighting system available

EFFICIENT;

➤ **SAFE LABOUR**

- one person can easily move it around and set it up

➤ **MOBILITY**

- rolls on its own casters (No extra trolley needed)

➤ **FLEXIBILITY**

- the flexible hang on system allows you to change the setup and look according to your needs



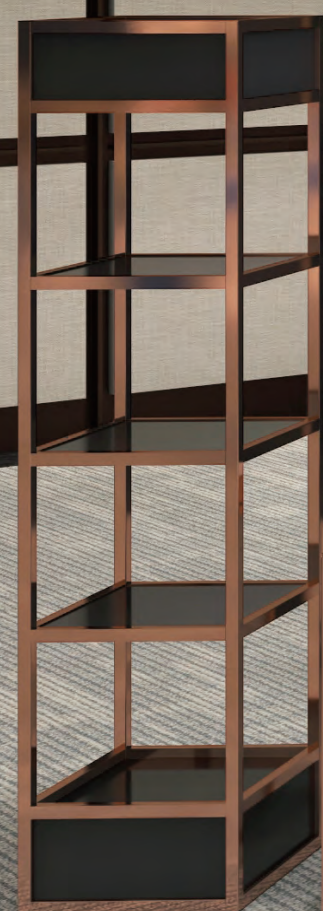

COMBINATION OF EVO BUFFET STATION, TABLES & DISPLAY TOWERS

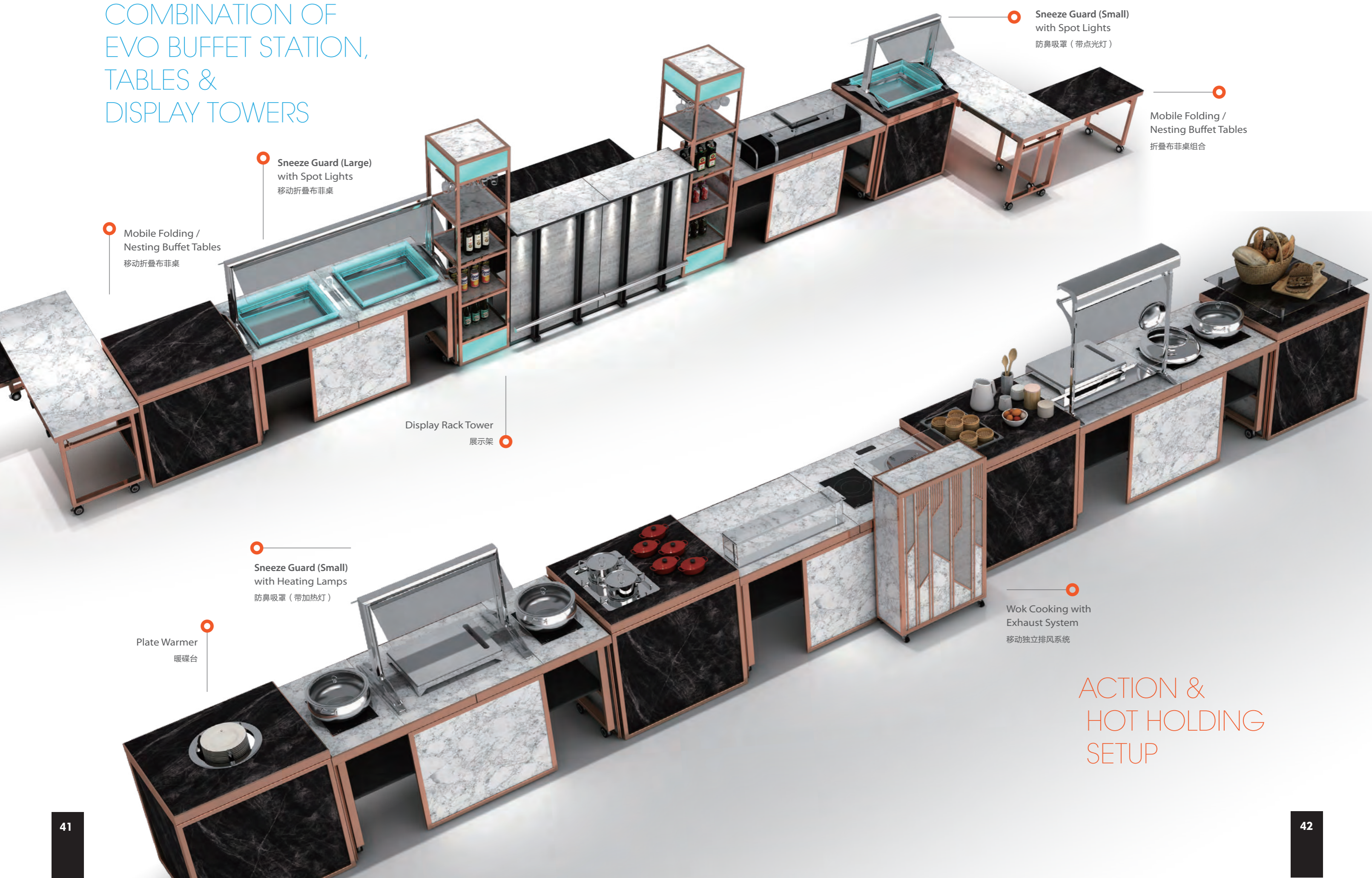

Mobile Folding /
Nesting Buffet Tables
移动折叠布菲桌

Sneeze Guard (Large)
with Spot Lights
移动折叠布菲桌

Display Rack Tower
展示架

Sneeze Guard (Small)
with Spot Lights
防鼻吸罩 (带点光灯)

Mobile Folding /
Nesting Buffet Tables
折叠布菲桌组合

Plate Warmer
暖碟台

Sneeze Guard (Small)
with Heating Lamps
防鼻吸罩 (带加热灯)

Wok Cooking with
Exhaust System
移动独立排风系统

ACTION & HOT HOLDING SETUP

COLD & HOT FOOD COMBINATION SETUP

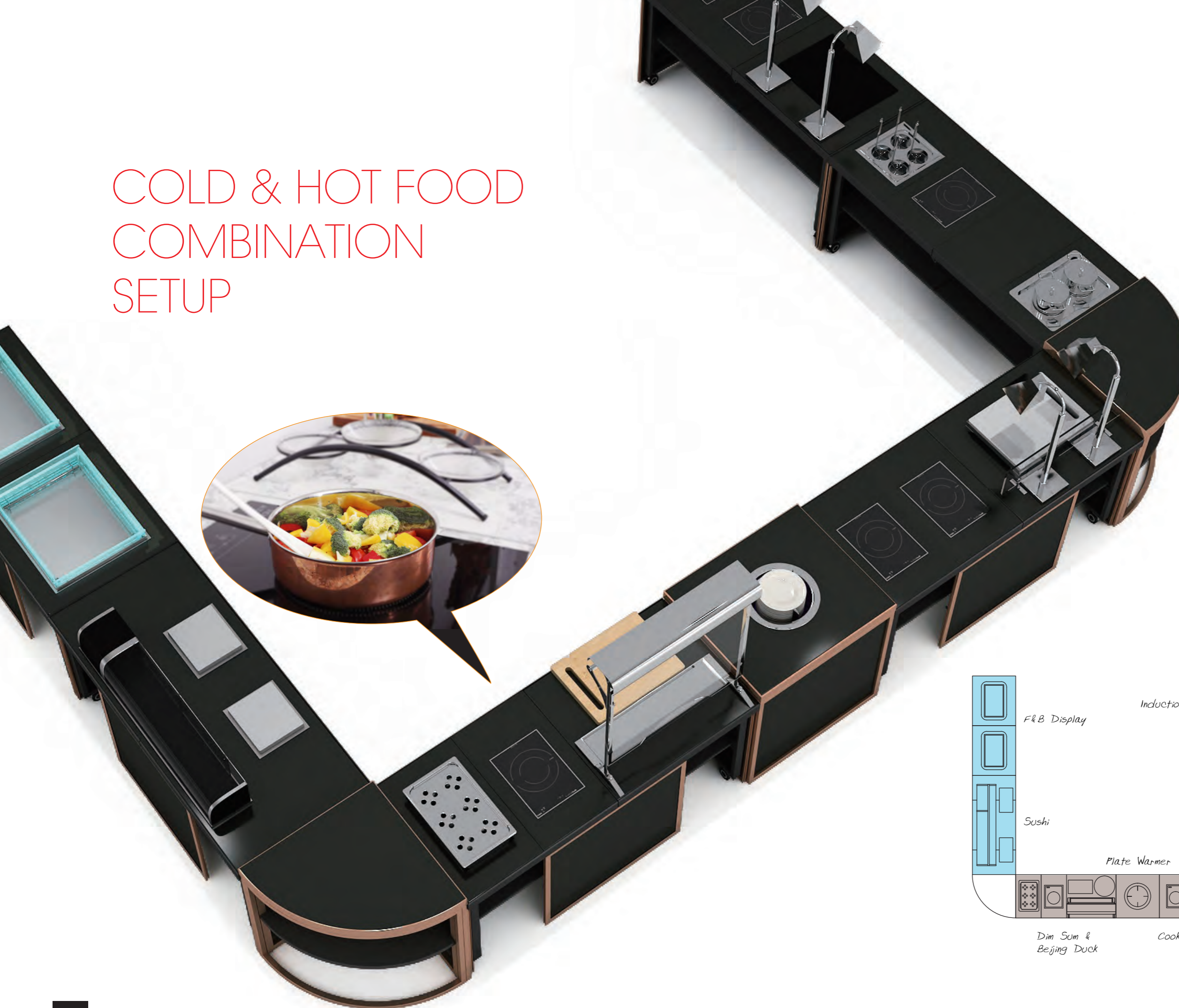

FEATURES

- 6 pcs Main Stations
- 1 pc Side Station (Plate Warmer)
- 1 pc Chinese BBQ Rack
- 4 pcs Heating Lamps
- 4 pcs Front Panel Middle Part
- 6 pcs Side Panel
- 2 pcs Corner Station
- 1 pc Sushi Fridge

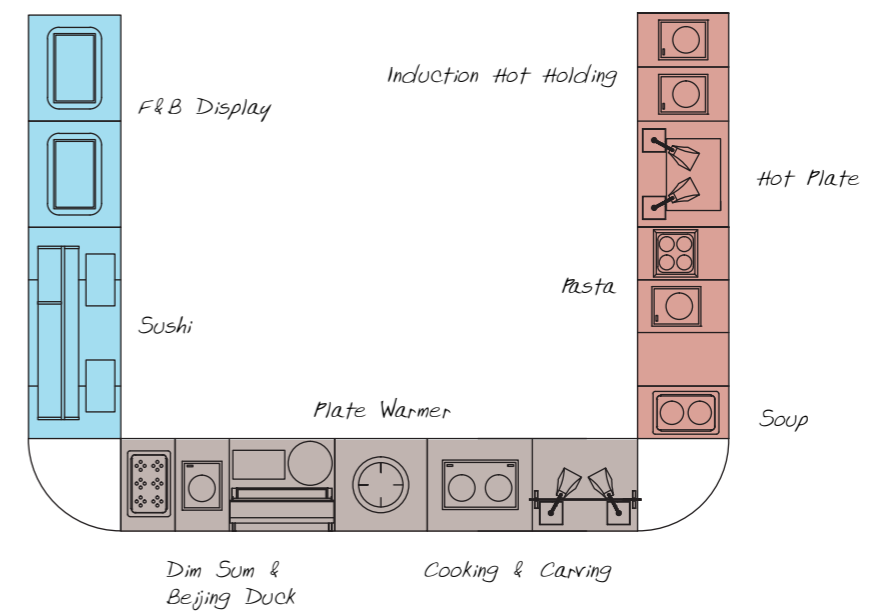

SERVICE BAR – COMBO SETUP

吧台

CREATE YOUR OWN...

Select the combinations to suit your event's requirement; from a single to a gigantic bar setup.

MATCHING PANEL COLOURS & PATTERN
MAKE IT BECOME PART OF THE WHOLE BUFFET CONCEPT

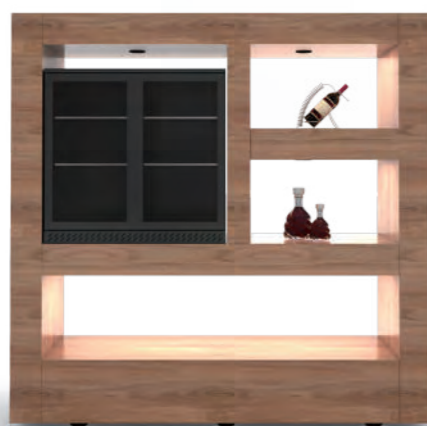

Mobile Display Rack "A"
J24SA-XMEXX



Mobile Display Rack "B"
J24SA-XMBXX



Combination of 3 mobile display rack,
1 multi-purpose station, 1 front riser, 2 F&B display side stations

COFFEE / DELI SHOP

咖啡吧展示架

With the matching materials & colour scheme, this setup becomes part of your F&B Function Concept – "CUSTOMIZED SETUPS AVAILABLE"



TURN YOUR
MULTI-PURPOSE
STATION INTO A
DELI / COFFEE
COUNTER



EASY SETUP & KNOCKDOWN
- suitable for EVO and Multi-flex concept

**Make a Coffee Bar, Bakery Display
or any Theme and Seasonal Event Setups**

STORAGE TROLLEY FOR "EVO"

储运车 - EVO款布菲

Upper Section

Slanted rails allow easy loading and unloading of modules



Middle Section

Designed to have maximum storage for front and side panels

Lower Section

For storage of various accessories, the folding front panel gives easy access to all the products



OCB2B

Specially designed to hold modules (1/4 & 1/2), middle front & side front panels and side panels, as well as accessories

Panel Trolley

If you are ordering a lot of Front & Side Panels, then this trolley is a great addition to the Combo EVO trolley



OCA1B - 001

Storage Cover

Optional you can purchase the designated dust covers for any of our "EVO & Multi-Flex" trolleys; Protect the stations from dust & dirt, make your storage look neat & tidy.

* They are very easy to use because of the Velcro open /closing system.

* Choose from Oxford fabric or canvas, both materials are durable and easy to clean.

TRANSPORTATION & STORAGE TROLLEYS

储运车 - 欧洲款布菲

Specially designed to hold the "Multi-Flex" modular buffet system; designated trolleys to hold the understructure middle shelf / all modules / the front and side panels.



OCA1B

"Multi-Flex"

Trolley for Front & Side Panels

- Holds up to 8 sets of Front and Side panels.
- Easy to load and unload.



OCB1B

"Multi-Flex"

Trolley for Modules

- Holds up to 4 complete set of modules (1/4 or 1/2 units).
- The yellow horizontal rails can be moved to adjust the spacing; so as they can hold different module heights.

"Multi-Flex"

Trolley for Understructure & Accessories

- Holds up to 4 complete sets of understructure and middle shelf.
- The specially designed top compartment can hold the heating lamps or additional accessories



OCD1B





A SMART DESIGN WITH A TOUCH OF ELEGANCE

Trendy - Great Top Selections - Various Combinations

Smart Design

Residential look; the removable panels come in modern, fashionable and traditional designs. The concept is to bring an open residential kitchen setups to your function rooms and outlets

THE SMART CONCEPT; a combination of various setup options, with many add-ons, to cater for small & big events. Various shapes & functions of products allow you to make a lot of different setups.

Create your own; easy to combine ambient & function stations with display & working cabinets as well as buffet & dining tables



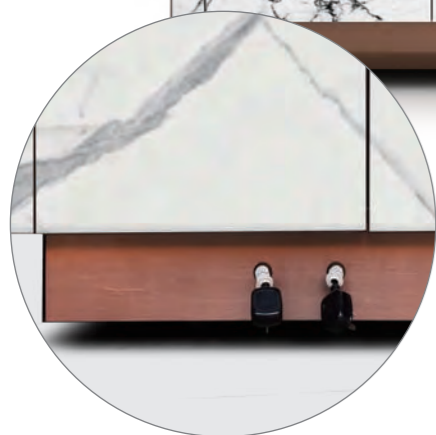

Power Management Solutions
* Retractable power cables

■ SHAPES & DIMENSIONS



L1850 x W800 x H850



L1015 x W800 x H850

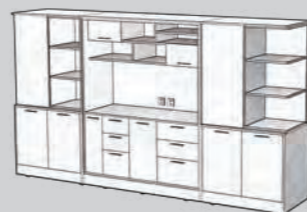

L3600 x W700 x H2050

MODERN OR TRADITIONAL RESIDENTIAL LOOK

The vast choices from modern to classic designer panel, gives you the opportunity not only to match your designs, but actually make your own creations.

*** with the removable panels you can change the look in no time and create the mood of your party

* For additional laminate options please contact our customer service.



STYLISH PANELS
- EASY TO CHANGE
任意更换专属风格的面板

We will make recommendations to you according your Interior design, so that our station becomes part of your venue

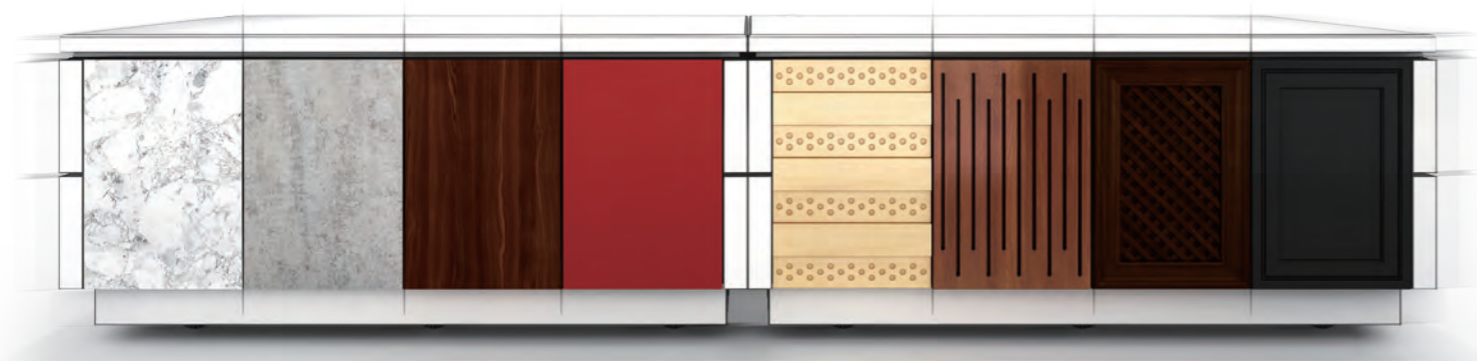
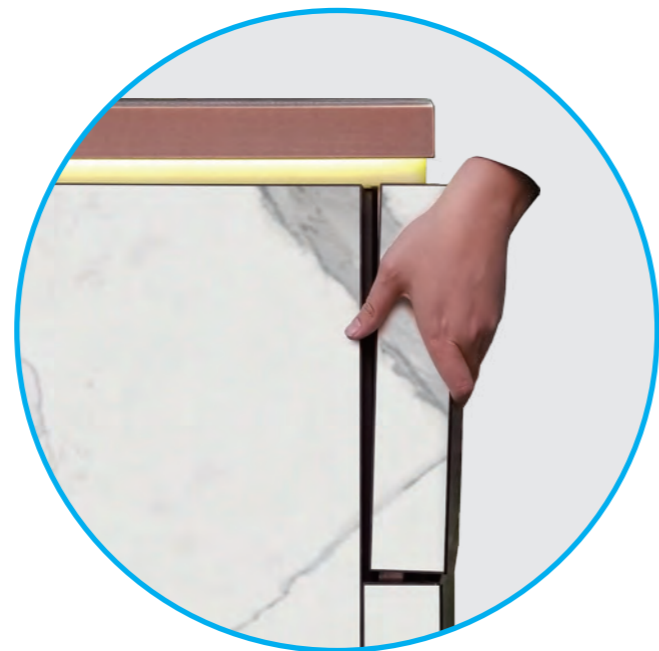

EASY TO MOVE AND RELOCATE
轻松移动台身至任意位置

- Heavy duty non marking casters assist to roll them away
- Designed that one person can move the product
- Efficient and fast setups and removal



LED LIGHTING SYSTEM
可变换颜色的灯光系统

Enhance the ambiance of your setups and give the "wow" effect





MOBILE BUFFET CONCEPT WITH SMART SCREEN

移动布菲系列 —— 智能显示屏



COMBINATION OF 3 MAIN STATION AND THE BACK DISPLAY WALL

- * Carving & Sushi
- * Desserts & Bakeries
- * Combo Hot Holding

➤ Panorama pictures and movies can stretch over up to 3 stations

➤ Build-in LED rim (between the screen & top frame), enhances the station when the TV panel is not on

➤ Rim-free screens, make the video and pictures look endless

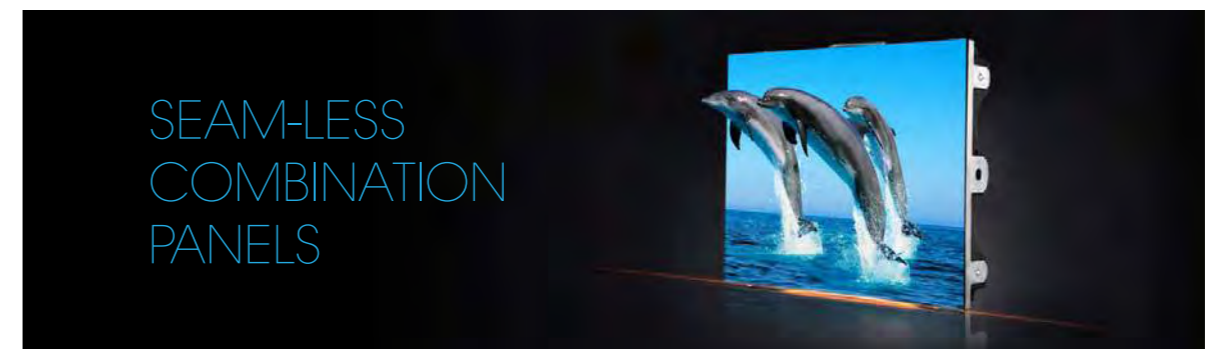
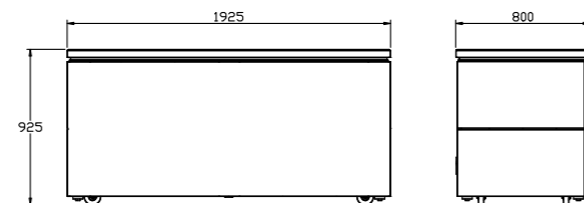

	HD		Wide Angle of view
	High gray scale		Seamless splicing
	Low power consumption		Adjustable brightness



MOBILE BACK DISPLAY CABINETS

可移动展示背柜

- Make combinations with the action stations or use them individually for Cocktails, Coffee Breaks or any Display setup
- They roll in and out of action on their own casters
- Display Shelves, cabinets and drawers can be customized to your needs

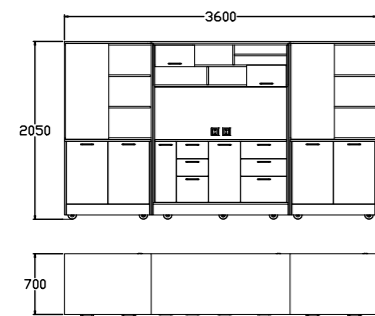

Combo Setup



Display & Action Cabinet



Storage & Display Cabinet

- **Sliding Door** - Allows you to make different setups

SMART COMBO SETUP

Action & Hot Holding Stations with Back Cabinets



SMART MAIN & SIDE STATION

Induction Cooking and Various Hot and Cold Food Displays





A SIMPLE DESIGN WITH MANY OPTIONS

Geometric - Time-less - Designer Options

Light Star 3

Modern Simplicity; Geometric structure with three individual removable panels and endless facial combinations are the main feature of this design.

Together with the matching side stations, bar and vertical display rack the whole concept is complete.

This Design comes in many combinations, such as custom made wood or acrylic panel patterns, print-on designs, laminated or synthetic leather boards and so on...

The easy removable panels give you the option of having different sets for various events, to give themed looks to your functions.



Compact Laminate Board with HPL Top finish
* Scratch and heat resistant

Top Configurations
* A great choice of combinations available

■ BACK VIEW



Additional Panel Options
* Designer Panels are available upon request



Front Panel (Removable)
* Middle Part – acrylic sheet with Onyx pattern and LED Lighting
* Optional – Designer print-on
* HPL wood panels – match your Interior design

Moves with ease
* On non-marking long lasting swivel casters

Side Panels (Removable)
* HPL wood panels – many colours and patterns to choose from
* Durable light-weight aluminum frame with various colour options

■ SHAPES & DIMENSIONS



L1800 x W850 x H850



L850 x W850 x H850



L1800 x W850 x H1200



L730 x W730 x H850

■ VARIOUS OPTIONS

Deluxe Laminate (REV-LAM)



3476H
Jet Sequoia



8830H
Elemental Concrete

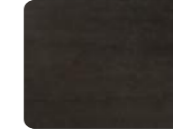

0909
Black

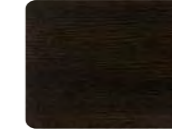

3421G
Bianca Luna

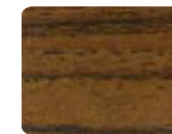

3423H
Travertine Gold



0909L
Black-Leather

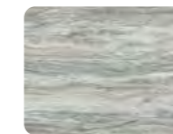

9302H
Fantasy Marble

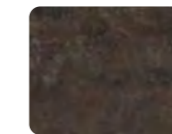

6417H
Elemental Oxide

Panel Frame Colour (Just to show a few)



CT11



CT09



CT08

Panel Setups



Laminate



LED Middle Panel with Designer Print on



LED Middle Panel with Onyx Pattern

MATCH YOUR INTERIOR DESIGN

With our removable designer panels you can easily give your own signature to the stations and make them match your function rooms. If you are looking for additional sets of theme function panels, they are also available and can be easy interchanged.



Stations with Designer Print-on Middle Panel

*For a????

Light Star 3
– Marble-LAM
多功能主台

Our REV-LAM (HPL) comes in stone / marble lookalike designs & pattern, which give this station an exclusive look. You can also choose from our vast choices of other materials & patterns to ensure the design blends with your interior



SIDE STATIONS
侧台

Great additions to your buffet lines –
Ideal individually for smaller events

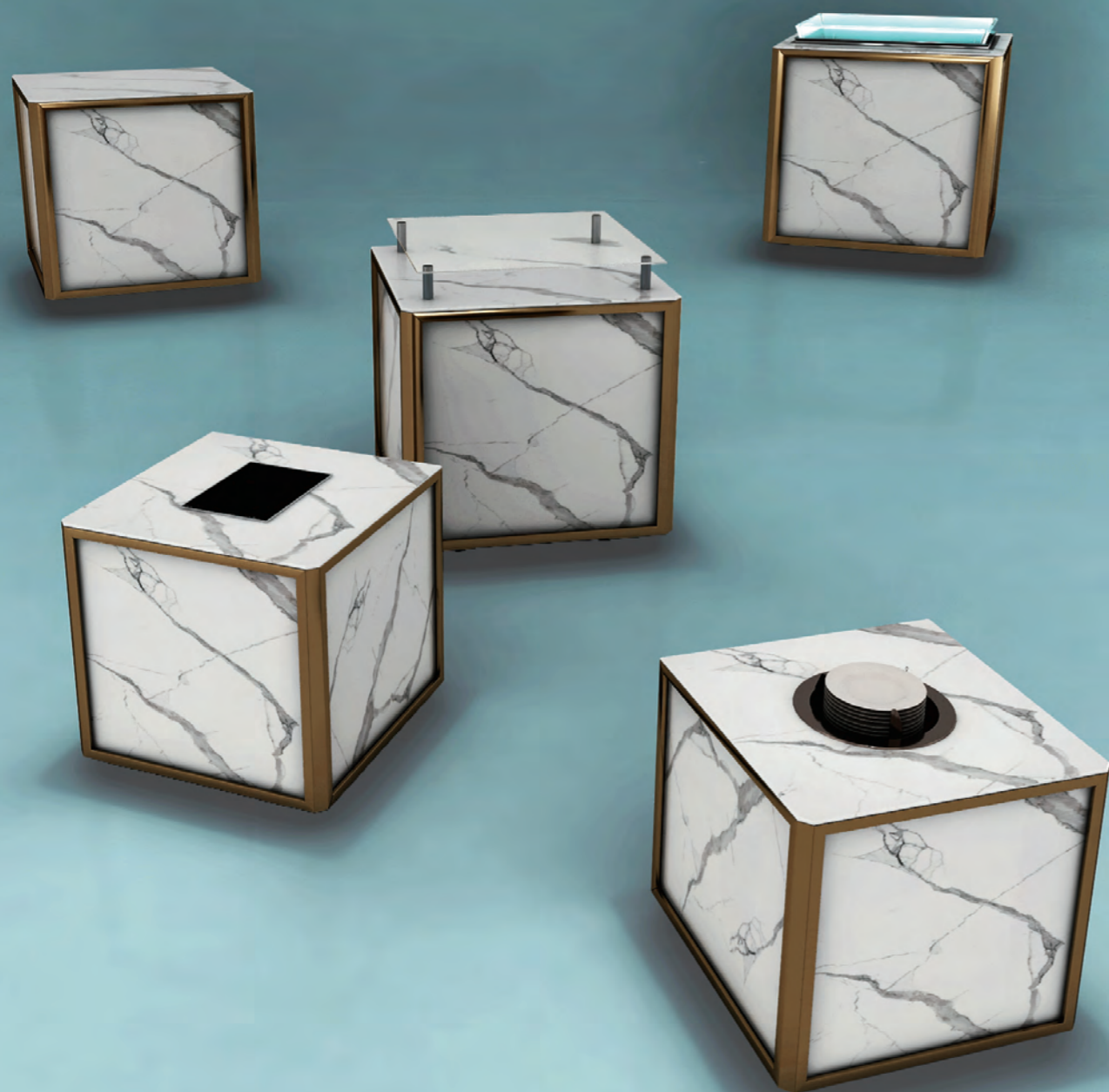

SST's Exhaust System

- Essential to have for all cooking stations.
- Ready when you need it; neatly set in the top when not in use, and at a simple turn of a switch the exhaust comes up and is clearing the smoke.



Grill - Flat Broiler
Standard



Grill - Flat Broiler
with Exhaust



IDEAL FOR
A LA MINUTE COOKING
OF PORTIONED FOOD

COMBINATION OF
DESSERT LINE

TOUR OF ASIA LINE

FEATURES

- 1 pc Ambient F&B Display Station
- 1 pc Ice Cream Station
- 1 pc Cold Display Station (Ice Well)

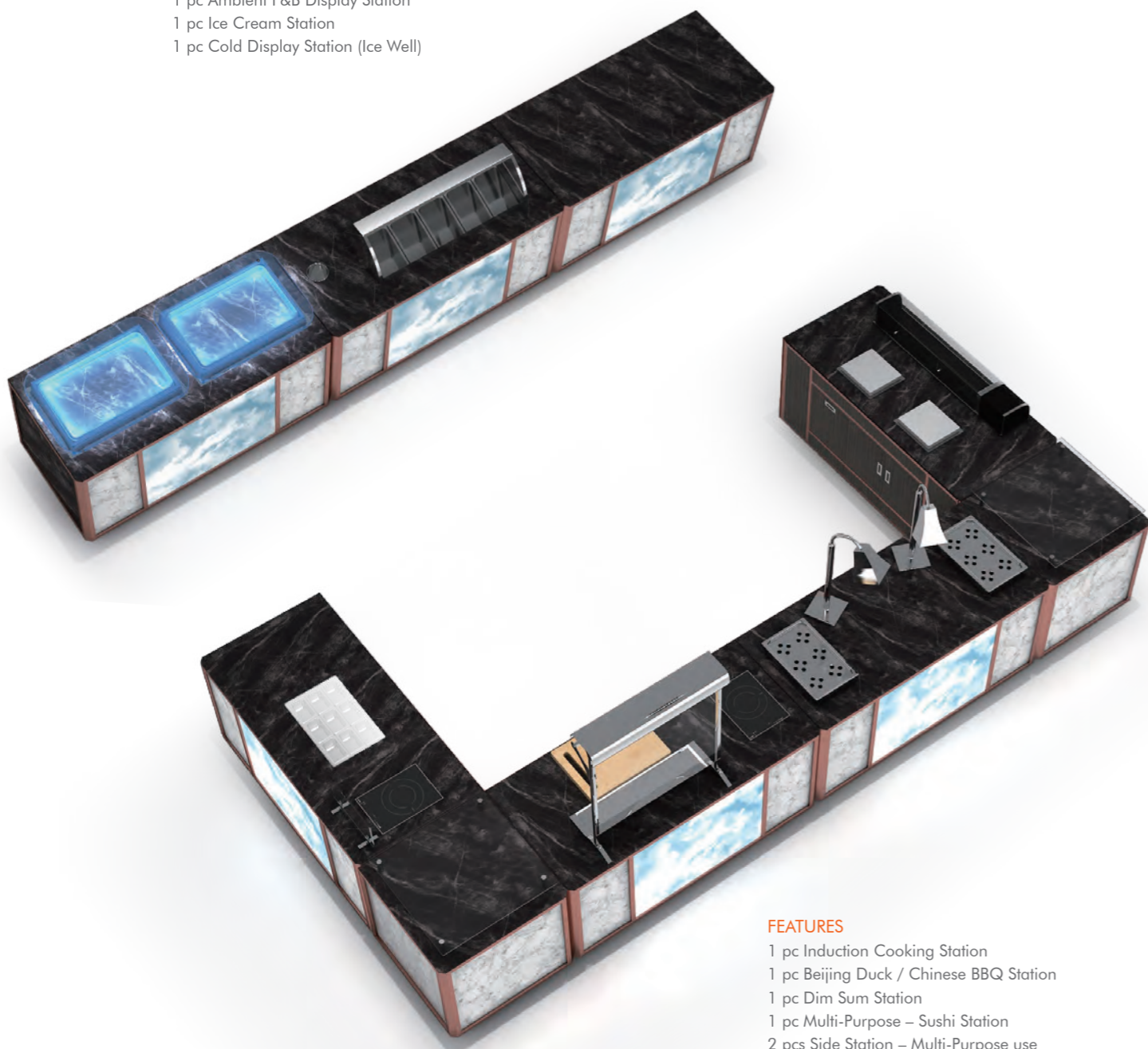

FEATURES

- 1 pc Induction Cooking Station
- 1 pc Beijing Duck / Chinese BBQ Station
- 1 pc Dim Sum Station
- 1 pc Multi-Purpose – Sushi Station
- 2 pcs Side Station – Multi-Purpose use

Light Star 3 – SERVICE BAR
吧台展示



CREATE YOUR OWN...

Let us work together with you and your Interior Designer, so that we can give the station "YOUR SIGNATURE TOUCH". We can custom design the panels by adding print-on, carved panels or simply the laminate colour and pattern to match your Hotels interior.



THE COMPLETE CONCEPT

Modern - Unique Innovation - High Tech

Cyber 3

A step in the future; new materials with state of the art technology and LED rim effects are the main feature of this design.

Combinations of different shapes and sizes, make it ideal for F&B presentations; your functions will never be the same.

Use the units individual and or combined; to suit all your various sizes and themes of events.



Invisible Induction Plates

* Hot Holding or Combo

Tempered Glass Top:

* Heat Resistant



Flip Tray

* For Condiments & Service Utensils

Hanging Glass Shelf

* For Display (Optional)

Hidden Casters

* The stations moves smoothly on the build-in wheels

Designer Front Panels

* With customized print-on



Down Spot Lights

Alu & PVC Protection Edge enhanced with a LED lighting system

* (6 still colours & 5 mixed colour programs)

Long Lasting Body

* Heavy duty steel inner structure
* Durable VCM outer body

Easy Relocation

* Moves on its own designated casters

Front Panel



LED



Designer Print-on

➤ Any setup, small or large in this design will surely "WOW" your guests; the look and the LED lighting effects are stunning.

■ SHAPES & DIMENSIONS



L1920 x W590 x H1980



L1800 x W700 x H900



L1250 x W520 x H920



L4830 x W550 x H1190



L1200 x W500 x H2000

FOR ADDITIONAL COLOUR OPTIONS AND CUSTOM DESIGNER PRINT-ON, PLEASE CALL OUR NEAREST SALES OFFICE

We offer the whole buffet display solutions with this design: ➤

- Hot Holding Setups
- Action Stations
- Display Racks
- Service Stations
- Multi-Purpose Bar / Reception Setup

MAIN STATIONS

多功能主台

The Cyber main stations come with all our standard top configurations (Let us know if you can't find what you're looking for)

Also you can choose from different body colour options and also front panel designs; simply plain or a designer print-on matching your hotels banquet interior.



COMBINATION OF HOT HOLDING

(Soup Terrines / Hotplate with Sneeze Guard & Top Heat / Induction Plate)

FLEXIBILITY WITH OUR MULTI-PURPOSE STATION

Ideas for any food presentations from the kitchen, with adding our designated accessories you have additional setup functions.

Also easy to change into a carving or show cooking station, by simply adding your own small table top cooking equipment.

In no time you can convert this into a beverage or coffee station and much more...

Western Carving with Heating Lamps



IDEAL FOR
PRESENTATION & SERVING OF
ANY TYPE OF HOT CARVING
OF MEAT & SEAFOOD

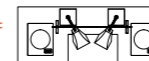

Noodle in Soup with heavy duty boiler



IDEAL FOR
CHINESE NOODLES,
DUMPLINGS AND VEGETABLES

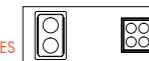

Hot Holding A3 with Heating Lamps



IDEAL FOR
CHAFING DISH (Round or square)
OR ANY INDUCTION FRIENDLY
FOOD PAN & CONTAINER

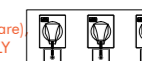

Cold F&B Display (Ice Well)



IDEAL FOR
SEAFOOD & SALAD BAR /
SUSHI & SASHIMI /
WINE & CHAMPAGNE BAR



BJ Duck & Chinese BBQ With removable stainless steel rack



IDEAL FOR
ROAST & BBQ MEAT
PRESENTATION,
COLD CUT & HAM SERVING



Flat Grill with Ice Well



IDEAL FOR
FOR A LA MINUTE GRILL
COOKING OF ANY KIND
SUITABLE MEAT AND SEAFOOD



Cooking Induction

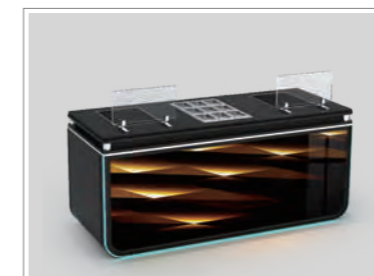

IDEAL FOR
A LA MINUTE COOKING
OF PORTIONED FOOD

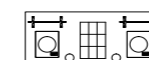

Steam Hot Holding with GN Boiler Unit



IDEAL FOR
HOT HOLDING OF
STEAMED AND DRY FOOD



Steam Hot Holding with electric Bain-Marie

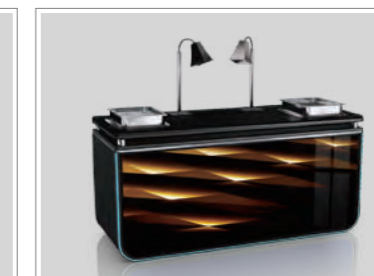

"CYBER 3" - Multi-Purpose Trolley / Station 多功能服务车 / 服务台

Use it as a mobile Coffee / Beverage Station, Snack setup or as an addition to any food display for your buffet line. How about a modern elegant looking Reception / Pre- function setup?

Change the mood - Use it during the day without the light and impress during the evenings with the LED light feature.

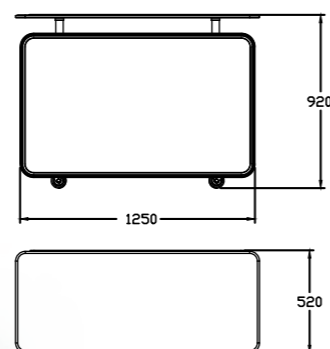

RS7AA-G0001

At the back we have incorporated two drawers and open storage space to suit your operational needs for various setups.



Imported deluxe casters not only make it easy and quietly to move, but also give it an elegant look.

"CYBER 3" - Oval Display Rack 椭圆形移动垂直展示架

A stunning way for any F&B presentations; spice up your standard buffet setups with our vertical displays.

LED Lighting System - it comes with plug in function.

Mobile - they run smoothly on their own caster, hence relocating them is very easy.

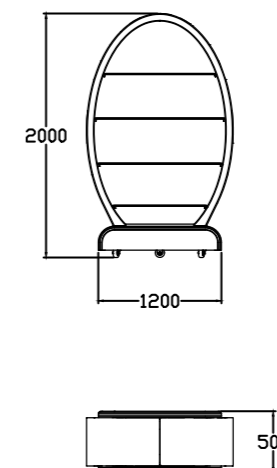

Use them individual or combined, and make your own settings; they make great back bar displays and can also be used as island setups for cocktails and buffet lines.

"CYBER 3" - Mobile Bar Modules And More...

智能时空款移动吧台

An innovative way of building your own size bar; easy to setup and relocate, can be setup in many different ways and sizes, that give you additional flexibilities when there are space limitations.



MULTI-PURPOSE

This design comes with many add-on modules, which convert the single display stations to small / large buffet tables, reception desk, information booth etc. Use different stations and modules to make the setups to your requirements.

REVERSABLE UNITS

双面吧台

The multi-purpose stations with designer vinyl panels look both sides the same, they can be reversed and or used as island setups. The LED rim comes with many additional features and gives it a new look for different setups.

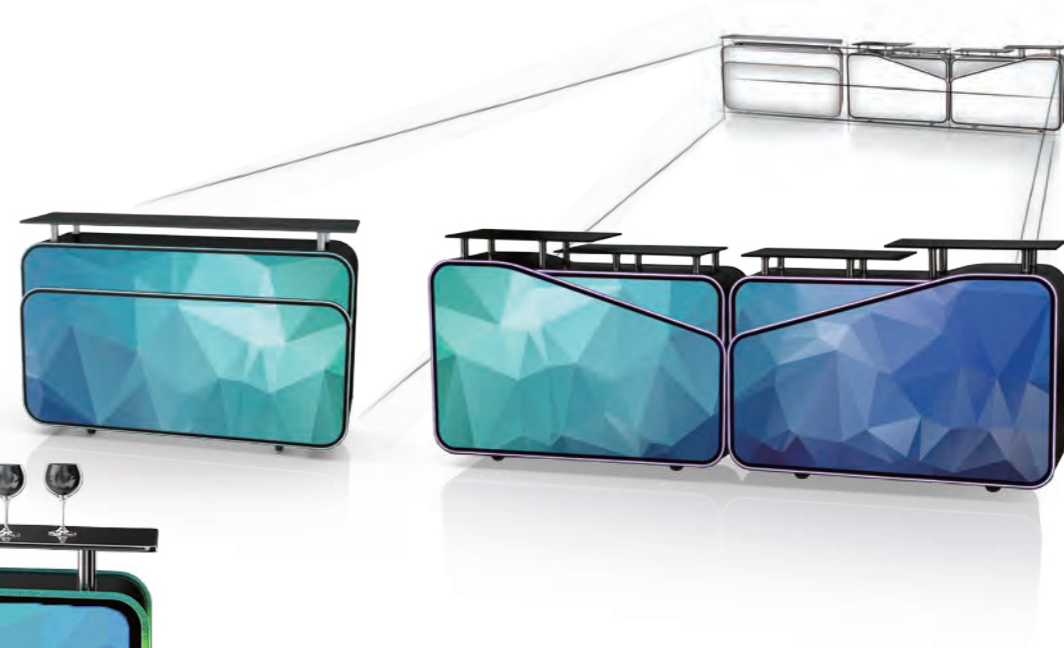

GREAT COCKTAIL BARS & FOOD DISPLAYS

No matter you want to make a small or large bar setup, or use them for snack, cocktail & dessert setups, they always enhance any F&B presentation.



A SIMPLE DESIGN WITH FLAIR & FUNCTIONALITY

Residential Look - Simplicity - Complete

Simplicity

This wood furniture give the buffet setups a simple residential look; a rustically veneer with matching colours and a straight forward design are the features of it.

Optional ambient cover available for the main stations; giving you more options as even the action stations can be used for multi-purpose setups.

The complete buffet line setup is available in Simplicity design; so you can create various different setups.





CHOOSE YOUR OWN COMBINATIONS FROM THE WIDE RANGE OF PRODUCTS IN THIS DESIGN. IT MAKES GREAT SMALL AND LARGE SETUPS.

■ OPTIONS

Wood Veneer - Paint Colours

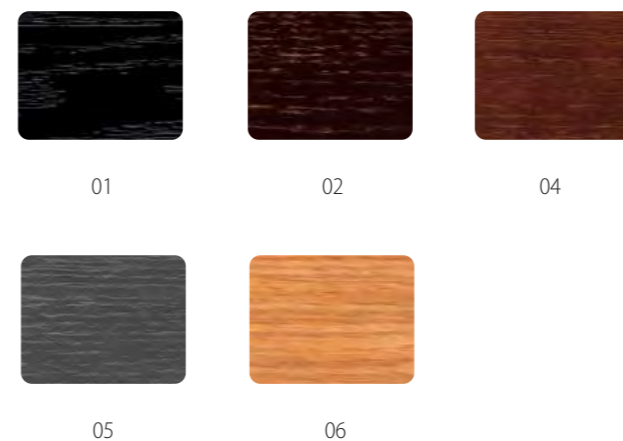

■ SHAPES & DIMENSIONS

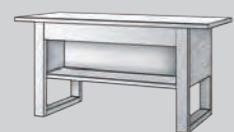

L1800 x W800 x H900

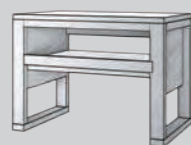

L1200 x W750 x H900



L1200 x W650 x H1100



L600 x W600 x H1000



L1400 x W500 x H2000



L510 x W510 x H800



L300 x W300 x H750

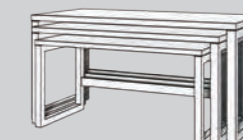

L1800 x W805 x H925

ACTION & DISPLAY STATION

- All in one
多功能主台

Most of the action station in this design can be converted to an ambient display table, by adding the matching cover. This give you flexibility and your setup can be changed instantly.

Induction Cooking & Hot Holding



IDEAL FOR
A LA MINUTE COOKING
AND HOT HOLDING OF
READY DISHES

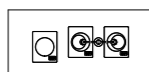

Carving & Hot Holding



IDEAL FOR
PRESENTATION & SERVING OF
ANY TYPE OF HOT CARVING
OF MEAT & SEAFOOD

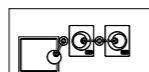

BJ Duck & Chinese BBQ



IDEAL FOR
ROAST & BBQ MEAT DISPLAYS,
COLD CUTS & HAM SERVING



Boiling - Multi-Purpose



IDEAL FOR
PASTA, DUMPLINGS
AND VEGETABLES

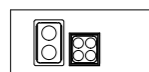

F&B Display with Ice Well



IDEAL FOR
SEAFOOD & SALAD BAR /
SUSHI & SASHIMI /
WINE & CHAMPAGNE BAR

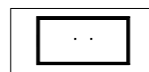

Side Station with Ice Well



IDEAL FOR
SEAFOOD & SALAD BAR /
SUSHI & SASHIMI /
WINE & CHAMPAGNE BAR



ACTION & DISPLAY STATION

- All in one
多功能主台

Steam Hot Holding

with GN Boiler or Electric Bain-Marie



IDEAL FOR
HOT HOLDING OF STEAMED
& DRY FOOD

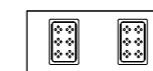

Grill Station

with an Electric Flat Glass Top Grill



IDEAL FOR
A LA MINUTE COOKING OF
PORTIONED FOOD

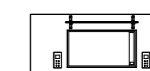

Wok Cooking

(Induction)



IDEAL FOR
ASIAN STIR-FRIED DISHES

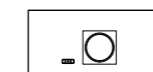

BJ Duck & Chinese BBQ

with removable Rack



IDEAL FOR
ROAST & BBQ MEAT PRESENTATIONS,
COLD CUTS & HAM SERVING

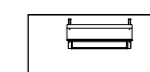

Service Station 服务台

Both sides accessible with built-in shelf and pull-out drawer, for ample storage space. Multi-purpose use, not only for plates and cups, but it also can become a Coffee / Beverage station.

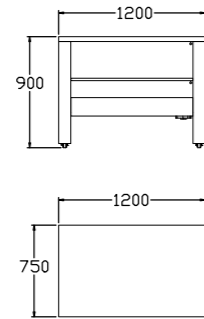

* Slide-out Tray

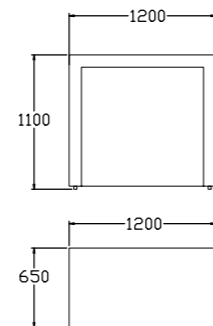

Bar & Service Counter 吧台 & 服务台

Setup as many as you require to get the right size of your Bar. Ample open space at the back allows you roll in your ice cube compartment, or storage Mise en place.

THE CONCEPT FROM A-Z 食品餐饮展示

We have the complete range of buffet stations, tables, bar and display racks & pillars available in the "Simplicity" design.

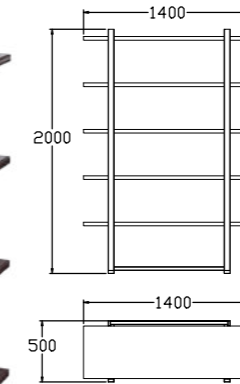

F&B Display Rack

A simple design which makes great presentations; use it as a back bar, F&B display or addition to your buffet setups. Different colour finishes are available for the shelves and the powder coated rack.

Display Columns "Simplicity" Design

They come in different shapes and sizes, ambient or with LED lighting. Use them to break up your buffet lines or as food displays.

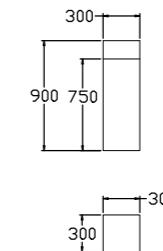

COMBO SETUPS

Make your own combinations of the display units, they make great cocktail & afternoon setups, as well giving your buffet line a unique look.

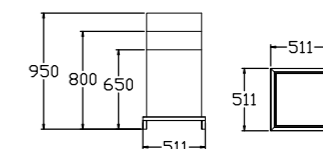

NESTING BUFFET TABLES 嵌套款布菲桌

A set of three gives you many different setup options. They move easy on their own casters, and can be nested and left in your foyer for displays.

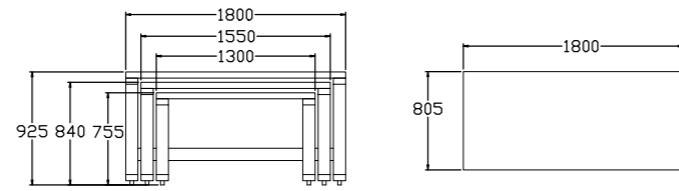

Mobile Buffet Tables "SIMPLICITY"

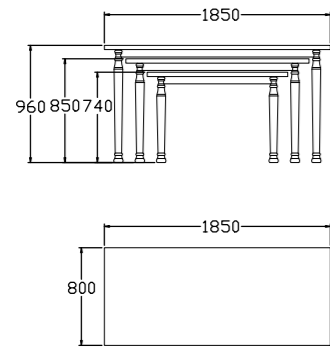

Buffet Tables
"Classic" (no casters)

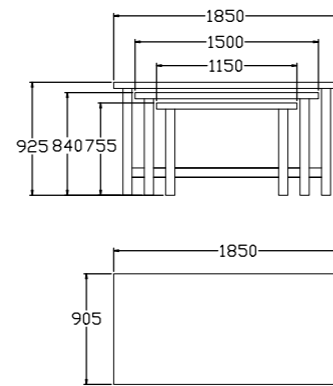

Buffet Tables
Set "D" (no casters)

COCKTAIL TABLES – Wood Veneer 鸡尾酒桌



A great addition to the warm residential looking wooden buffet station concepts. Coming in matching finish and colours for various designs. They are for small and large cocktail functions as well make fantastic add-on and risers to any buffet line.

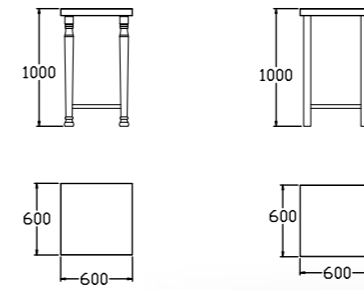

"Simplicity" Design
TCAXC-TISFA



"Classic" Design
TCAXD-TISFA

OPTIONS

- Customization available – let us know what are your requirements
- Stylish glass top liners or inlets
- Choose from a vast choice of colour finishes
- Round top version available



Main Bars

吧台

We make mobile bars in all of our buffet designs, and many options, colours and material finishes to choose from. From a simple to extravagant setups; we have something available to suit small to large parties.

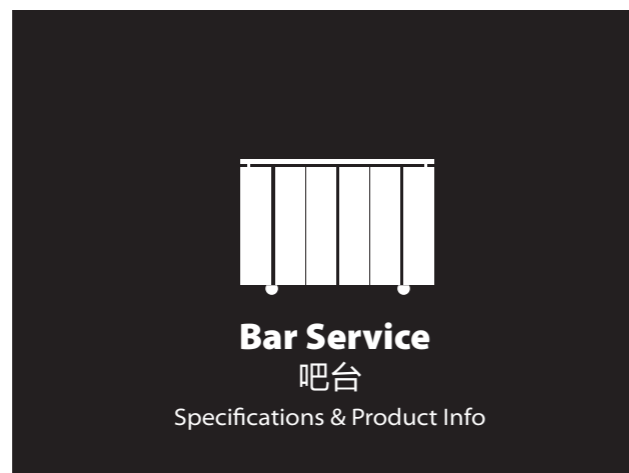

BARS

Modern - Unique Innovation - High Tech



- Options**
- Stainless Steel Sink with Drainage
 - Ambient Top
 - Drawers or Storage Cabinets
 - Ice Cube Compartment (insulated, with drainage)
 - Glass Rack Tray Holder
 - Garbage Bin (Build-in)



High quality MDF Boards
 *** with HP Laminate finish

BAR - Traditional 传统吧台

Inner wood structure with outside stainless steel, this bar is protected by our SICO Armor Edge; it runs smoothly on its own caster base, and comes with standard back features.

Features:

- Marble Service Top
- Stainless Steel Work Top

Front Panel Options:

- Synthetic Leather with Designer Print-on
- Laminates in many colours and patterns



BS3AX

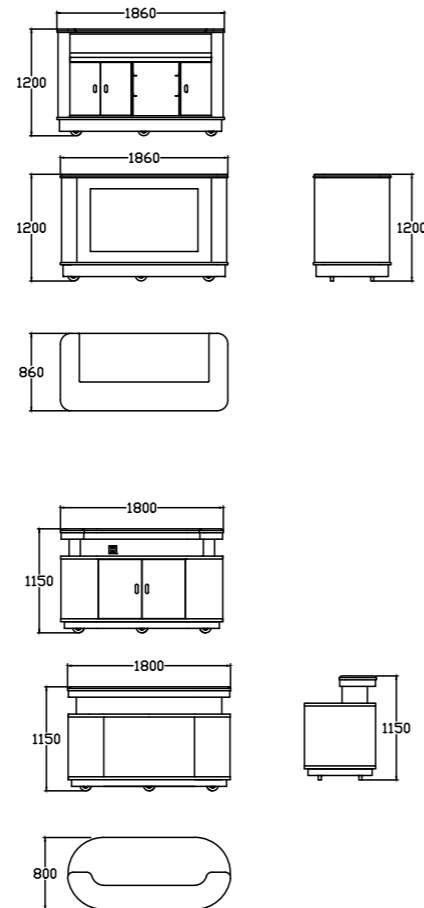

BAR - Elegance 优雅吧台

The combination of VCM and stainless steel finishes, and its shape are the main features of this design. Additional LED lighting underneath the top front part is enhancing it.

Features:

- Marble Service Top
- Stainless Steel Work Top
- Power Socket (build-in at the back)

Front Panel Options:

- Synthetic Leather with Designer Print-on
- Laminates in many colours and patterns



RW0AJ

BAR - COMBO "LIGHT STAR 3" “星光款3” 组合吧台



Combo Setup
(with Designer Print-on)

FEATURES

- 1 pc Main Service Bar
- 2 pc Side Station - F&B Display (Ice Well)
- 1 set F&B Display Tower Racks



CREATE YOUR OWN...

Let us work together with you and your Interior Designer, so that we can give the station "YOUR SIGNATURE TOUCH", We can custom design the panels by adding print-on, carved panels or simply the laminate colour and pattern to match your Hotels interior.

Multi-Purpose – Bar / Reception / Sales or Info Counter 多功能吧台

HIGH PRESSURE LAMINATE PANELS WITH A STYLISH ALUMINUM PROTECTION EDGE (ANODIZED).

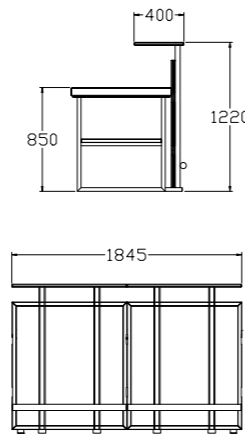

One Multi-Purpose Station combined with two Bar/Reception Front Modules

Special Feature;

- Designed for multi-purpose use, suitable for EVO and Multi-Flex Stations.
- The front leg support enhances the bar feeling
- Top folds for easy storage
- Two front casters make it easy to relocate



SERVICE BAR – COMBO SETUP 吧台

CREATE YOUR OWN...

Select the combinations to suit your event's requirement; from a single to a gigantic bar setup.

MATCHING PANEL COLOURS & PATTERN
MAKE IT BECOME PART OF THE WHOLE BUFFET CONCEPT

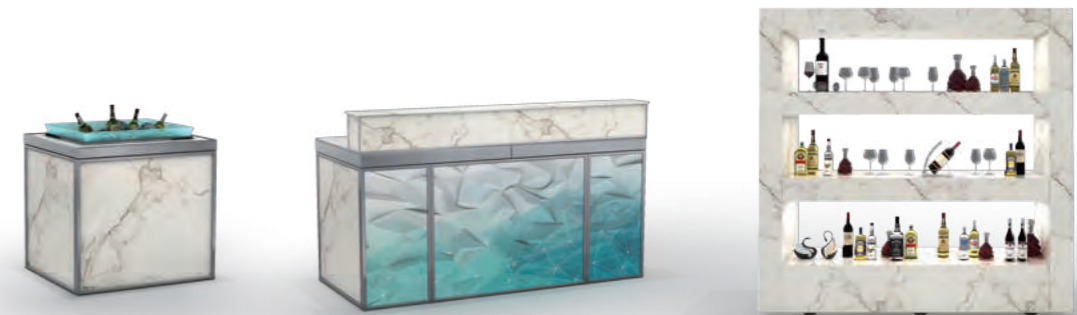

Side Station (F&B Display)

Multi-Purpose Station with Riser

Vertical Display Cabinet

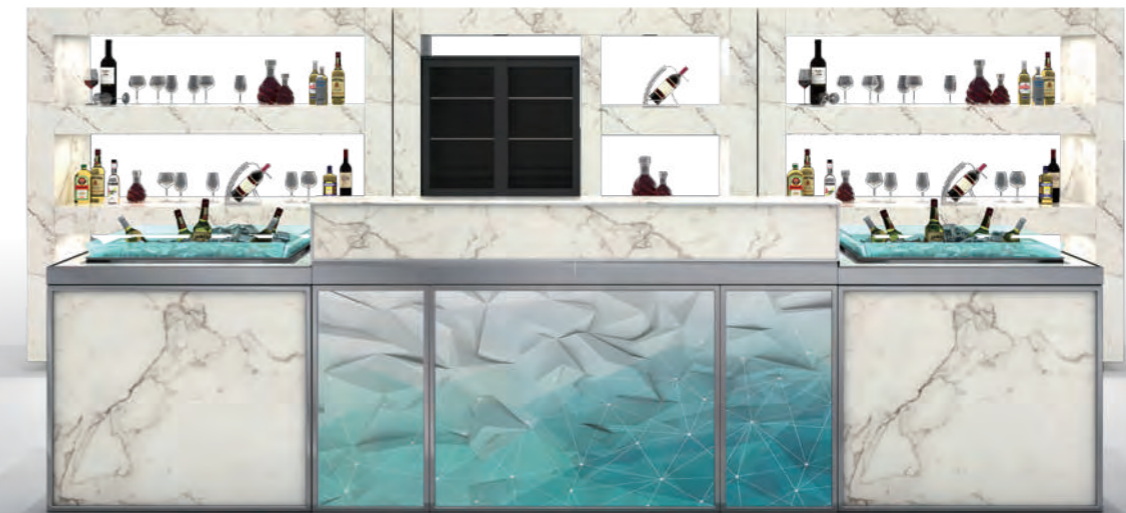

DELUXE COMBINATION BAR

(3 mobile display racks, 1 multi-purpose station, 1 front riser, 2 F&B display side stations)

BAR - MULTI-PURPOSE "Cyber 3" "时空款3" 多功能吧台

An innovative way of a simple, modern and fancy bar or cocktail event.

The stations with designer vinyl panels look both sides the same, they can be reversed and or used as island setups. The LED rim comes with many additional features and gives it a new look for different setups.



BAR SERVICE

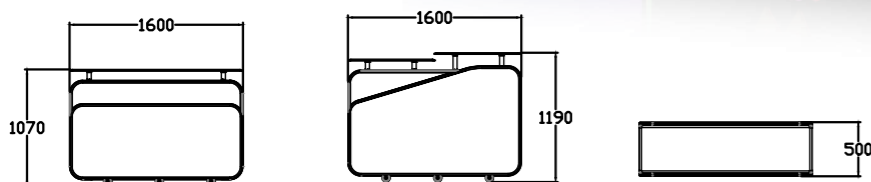

Bar & Service Counter 吧台 & 服务台

Setup as many as you require to get the right size of your Bar. Ample open space at the back allows you roll in your ice cube compartment, or storage Mise en place.



SERVICE BAR 服务吧台

Deluxe Bar – Comes in various colors, with a high quality lacquer finish. The front has an acrylic section with remote controlled LED lighting system.

Features;

- Marble Service Top
- Stainless Steel Work Top
- None-marking Solid Casters

Options;

- Build in Ice Cube Compartment
- Sink with Drainage
- Designer Front Panel



BS0AX-B32
(with insulated ice cube compartment)

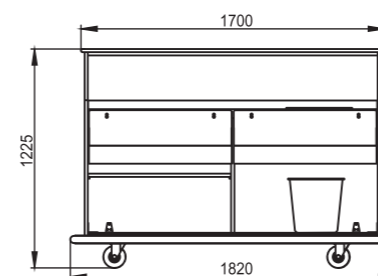
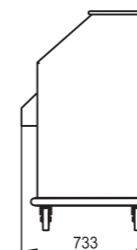

Standard Bar – Durable steel structure with melamine finished MDF panels, and an all-around PVC bumper, make this a long lasting product.



(Back View)



BS1AX



WE OFFER A WIDE
SELECTION OF BOTH

*From Traditional to Modern /
Wood, Glass & LED Tops /
Fixed / Folding / Mobile*

Buffet & Cocktail Tables

(fixed & folding)

Understructure; Available in different materials, colours & finishes

Tops: Removable tops are available in glass or wooden and can come with LED lighting (depending on model)

LED Top System; with durable Patented PVC Protection Edge & LED rim, build-in LED rechargeable battery system (saves up to 50% storage space)
(6 still standard colours & 5 mixed colour programs - push button controlled)

Transport & Storage Trolleys; Makes it easy for your day to day setups & moving



BUFFET TABLES – with a Spark

“耀目款”布菲桌



TCRX1

Endless Options;

- Removable Top & Foldable Understructure
- Aluminum structure with LED Light
- Great choice of anodized colours
- Modern and contemporary tops
- Transport & Storage trolleys

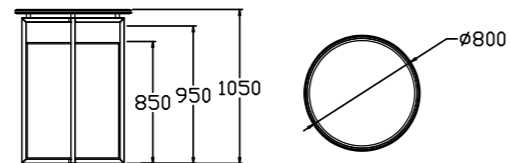

Besides the easy handling, the LED feature build into the frame, give it the right mood for any cocktail party.



BUFFET TABLES – “LED FRAME”

布菲桌-LED框架

Removable Top & Folding Understructure; this tables are easy to handle, moved in and out of action in no time and have a vast choice of finishes available.



Anodized
Silver

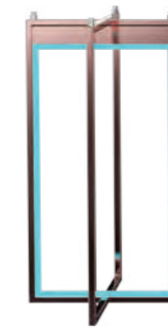

Anodized
Rose Gold



Anodized
Black

TOP OPTIONS



Laminated
(Stone / Marble)



Laminated
(Solid Color)



LED
(with Designer Print-on)



Laminated
(Wood Grain)



Glass Top
(Clear, Frosted)



SST LED Top
(Build-in Battery)

BUFFET TABLES - with LED Tops

LED桌面布菲桌

Our patented LED top comes with a durable protection rim and a build in rechargeable battery, which makes it slimmer and easy to handle

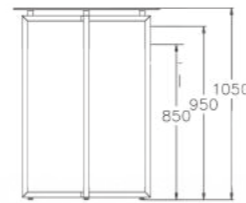
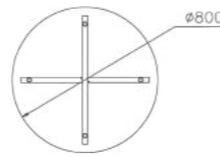

ROUND

- suitable as Cocktail Table



SQUARE

- suitable as Cocktail Table



RECTANGULAR

- suitable as Buffet Table



CRESCENT

- available in 4 & 5 to a circle

New Folding Frame:

全新折叠框架—— 人性化设计, 防夹手自动锁定装置

► Damping locking device

► Advanced locking system;

Automatic locking system engages to lock the frames safely in closed and open position

ANTI-PINCH

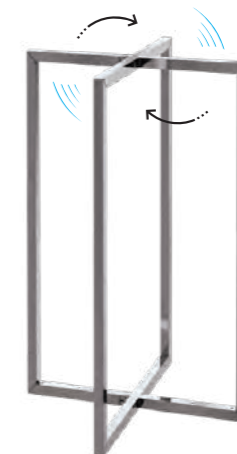

TRANSPORT & STORAGE TROLLEY "Flexi" BUFFET TABLES

“灵动款”布菲桌储运车



OC51B

- This combo trolley can hold up to 10 sets of square or round buffet / cocktail tables.
- We also offer trolleys for tops and trolleys for understructure only; they are designed to hold all other "Flexi" buffet table shapes.
- Add-on Charging Station (optional)

BUFFET TABLE – Waterfall System

“瀑布款” 布菲桌

Each shape comes in a set of three, and all can come with our different standard top finishes

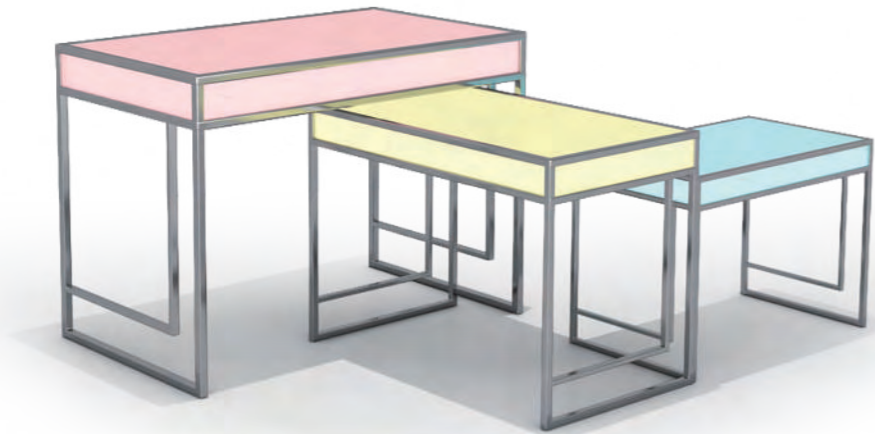

Various Options;

- **Shapes;** Round, square, rectangular and ¼ round.
- **Understructure;** As a standard they come in brushed stainless steel, but also available in powder coat and electric paint finish
- **Tops;** Besides the LED light we recommend frosted and tinted glass, or perhaps you like the wide range of our designer glass tops



Advantages of Nesting Tables;

- Waterfall design gives you a lot of different setup possibilities
- Storage; easy to nest and store at minimal space



Buffet Tables (Nesting) “Multi-Purpose” 多功能嵌套布菲桌

Our designer put simplicity & practicality into this design, and with the material chosen it is the perfect match for the EVO & Multi-Flex buffet stations, and also looks great by its own.

Tops:

All options are neatly set into the frame, they are easy to be interchanged, hence you could order various top panels to change the buffet table style to match your event or the mood of the day.

Tempered Glass Tops – Frosted, clear or tinted

Laminated Tops – Endless patterns & colours available

Designer Tops – Exciting prints & designs to choose from

Frame / Understructure

Our high quality stainless steel structure are available in brushed, electric paint, wood grain and powder coat (steel structure) finish

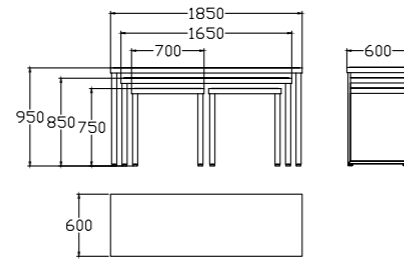

Buffet Tables Add-on 布菲桌配套设备

Storage space saving – as they are designed to stay in your foyer or lobby; when not in use for events they make great displays

Table Leg Options



Table Top Options

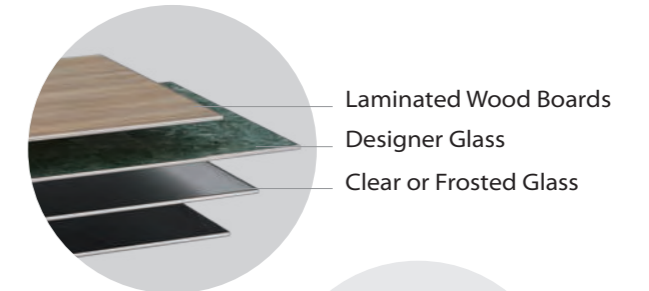

Mobility:

this tables can be fitted with optional casters or one set fits nicely on the designated transport trolley



Table with Casters

Imported deluxe casters not only make it easy and quietly to move, but also give it an elegant look.

Transport Trolley

- Easy to load and unload
- One complete set can be moved at the same time
- None-marking solid casters
- Fast & efficient method to relocate your tables



COCKTAIL TABLE – “DELUXE”

“奢华款” 鸡尾酒桌

This elegant simple design comes with removable top, hence you can have different tops to change the mood of your functions.

➤ LED Top

➤ Tempered Glass Top

➤ Laminated Wood Top

*** with our SICO Armot Edge

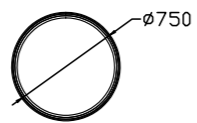
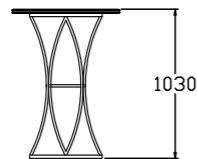

TCEL2T2C



High Quality Stainless Steel Understructure

- comes in brushed, polished or black powder epoxy finish



COCKTAIL TABLE “FLEXI”

“灵动款” 鸡尾酒桌

If storage space is an issue, then this is the right table for you; removable top and folding understructure, they are neatly put on our transport and storage trolleys

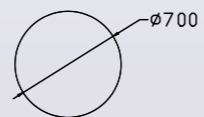
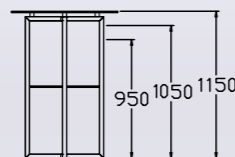

COCKTAIL TABLE – “OVATION”

“悦动款” 鸡尾酒桌

- Stylish understructure with build-in LED lighting system (with rechargeable battery)
- **Tops;** Choose from our patented LED or HP laminate top (Customized tops available upon request)
- Specially designed slim base ensures stability

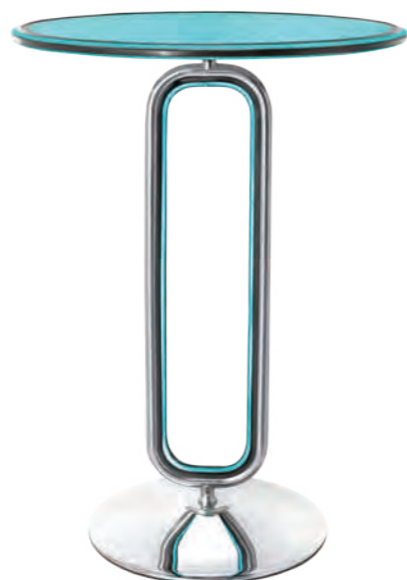
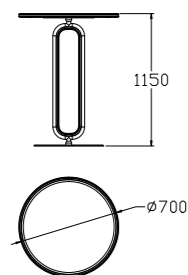

TCQL3TAX

Chic Design – with High Quality Stainless Steel Understructure

- Refined chrome plated steel base
- Polished finish gives a modern look

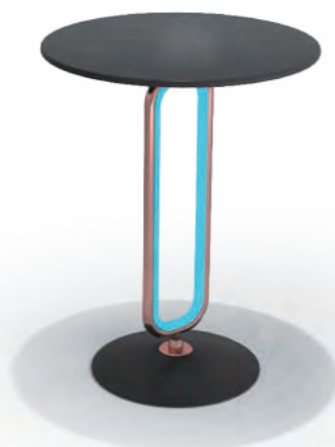

COCKTAIL TABLE – PULLOUT TRAYS

鸡尾酒桌 – 带推拉盘

Space saving & functioning concept; Our SST designing & developing team have put all of it in this great design.



Hexagon



TCGM6

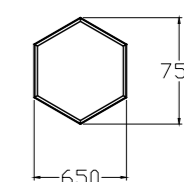
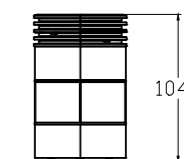

Both the hexagon and round shaped tables can be used as tower display or cocktail / snack table – depending on your function needs, you use none or 1-3 pull out trays

“Serve your F&B in Style” and let your parties be the talk of the town

The high quality water resistant materials make it the ideal table for in- and outdoor events.

Choose from a vast range of colours, finishes and various top options; this lets you customize it to be your own design.

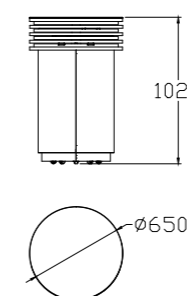

TCGM5





MULTI-PURPOSE CHOICES IN ONE DESIGN

*This versatile table and its flexible height adjustment
is perfect for any event*



CHIC COCKTAIL TABLE
 – ADJUSTABLE HEIGHT / FOLDING TOP
 别致的顶部可折叠鸡尾酒桌



TCSX5-TXAXK



Table Top; MDF Core with HPL (many colour and patterns to choose from), and protected by our Armor edge.

Unique Folding System; Allows tables to nest together, saving storage space

Adjustable Height; by simply lifting the lever you can put the height anywhere between (770-1030mm)



MOBILE PARTY COCKTAIL TABLE
 – FOLDING TOP
 新款移动可折叠吧桌



TCSX5-TXAXC

SMOOTH HEIGHT ADJUSTMENTS
 – simply lift the lever and set the top at required height

Optional;
Laminated Top
 – choose from endless varieties
Square Top
 – with the same functions as the round version



TCSX5-SXAXC



DELUXE CASTERS
 – not only make this table easy to move, but also enhance the design

THE IDEAL TABLE FOR MULTIPLE USE;
FOR SMALL VIP SETTINGS TO LARGE COCKTAIL PARTIES.
EFFICIENT AND EASY TO SETUP AND STORAGE.

ALUMINUM UNDERSTRUCTURE

– comes in anodized finish;
choose from a simple matt colour or go fancy with a striking colour





DESIGNED FOR MULTI-PURPOSE USE

Used Individual / Combined / Add-on

Mobile F&B Display

MULTI-PURPOSE – We offer various designs of display racks, cabinets or towers. They come in different materials and styles, so you can choose the one which matches your hotel concept. They make great addition to your buffet lines and can be used as island displays

MOBILITY – Some of the designs have their own casters, others come with a designated transport & storage trolley. Either way it is easy to relocate them if needed

STORAGE – As the design will blend with your interior, most of our display racks can be left in your foyer or venue, they do not require additional storage space

The aluminum finish, glass trays and LED lighting give them an elegant modern look. And the 1/4 round shape gives you various setup options.



GREAT BACK BAR DISPLAYS

They move easy on their own casters and enhance any bar setup. Use them as back display and or F&B walls, individual or in combination with other buffet products.



Combination of Four Racks
(closed back)

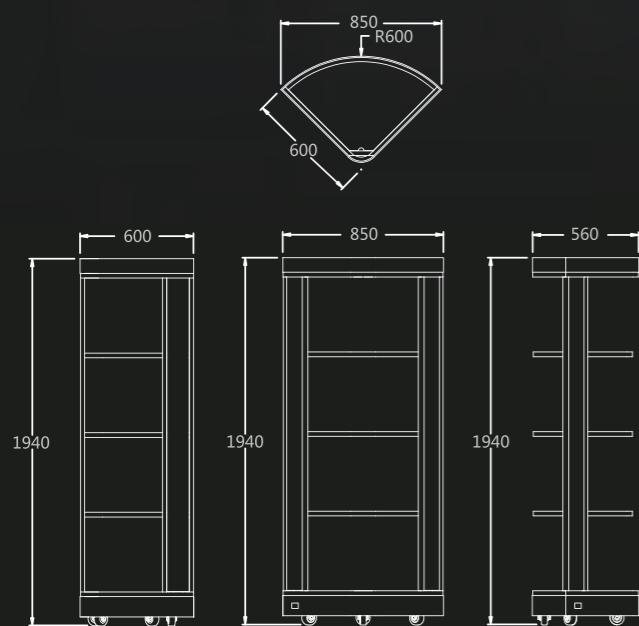

JO6C4-AMCXX-004

TOWER DISPLAY

移动展示塔

The 1/4 round design makes them ideal to be used individual, as a straight or curved line, and also as a round pillar. It fit any setup from small to large and always makes a stunning stand.

Single Rack
(open back)



JO6C4-AMCXX-006

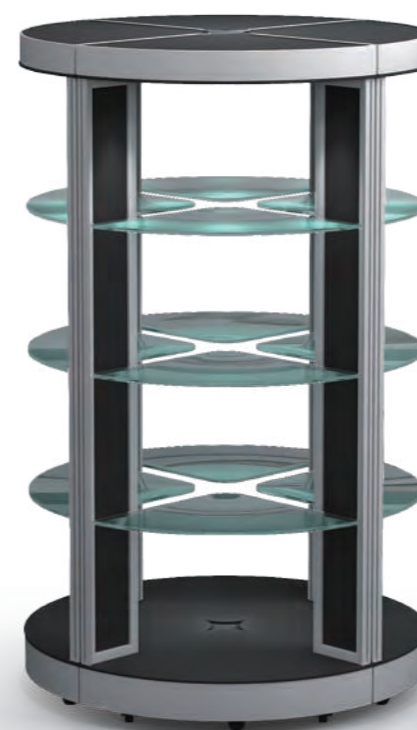

Storage Made Easy;

They blend into your foyer and function room as part of your Interior design. Easy to decorate and move to the location where needed

Combination of Four Racks
(open back)

F&B DISPLAY RACK - Foldable 可折叠食品展示架

Modern display, easy to setup and store.
Accessible from both sides, hence ideal for island setups.

► **Frame;** Made of strengthen aluminium, available in many different colours (anodized)

► **Panels;** choose from glass or wood panels in various finishes

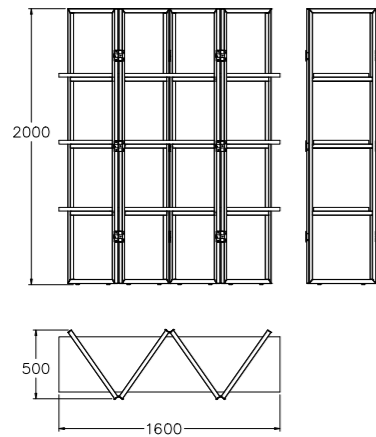

J23SA-AFAAL

Mobile F&B Display Rack 展示架

"Simple yet Elegant" – comes in a wooden structure with a high quality furniture lacquer finish.

► **Mobility** – moves smoothly on its own casters

► **Closed Storage Cabinet** – gives you additional space for your "Mise en Place"

► **Various Colour & Pattern Options** – Our designer will customize it to match your surroundings

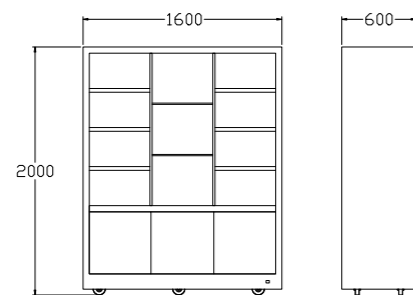

JO9SA



DISPLAY TOWER RACK 餐饮展示架

This popular display setups come now NEW with an anodized aluminum frame.
Use them individual, as part of the buffet and make combination racks by using connection panels.

► **Aluminum Frame;** choose from a vast range of colours

► **Towers come in three different heights;** this gives you endless setup / combination opportunities

► **Lighting;** this displays are equipped with an up and down lighting as well as build in LED strips

► **Connection Panels;** Optional you can order various panels to build display shelving or back bars

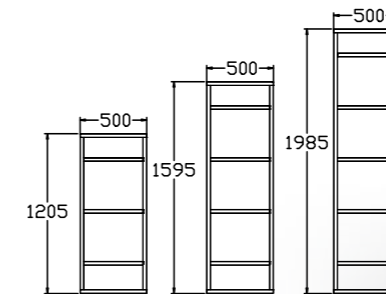

Combination Setup



MOBILE & FLEXIBLE

Our cabinets come in many different shapes and sizes, they can be used individually as well as combined. They roll on their own casters, which allows you to move them easily from location to location.

Coffee Break Cabinets

Flexibility; the setups can be used as part of a service section or as an self-service corner

Efficient Space Usage; the doors when open, provide plenty of display space, and when closed the cabinets can stay in your venue

Easy Moving; this units can be relocated in no time.

Multi-Purpose; Use them as back bar, displays or a complete coffee station setup.

Customization; the inside configurations can be tailor made to your needs

COFFEE & BEVERAGE CABINET

咖啡 & 酒水展示柜

Aluminum Frame

* Durable and light-weight;
colour can be customized

Push-Drawers

* For condiments
and accessories



Power Management

Non-marring Casters

* Allows easy changing and
relocating of the setups

Storage Space

* Conveniently store
your "Mise En Place"

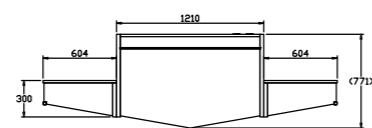
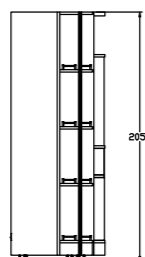
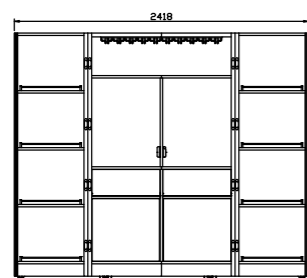

GO2AAI2



* Coffee & Beverage Display

Space Saving

* No additional storage space is
needed, as the closed cabinets can
become part of your venue setup.

* Storage Position



COFFEE BREAK CABINET

咖啡柜

SAVING SPACE AND LABOUR – They are always ready to use, one person can arrange them in a short time to be operational. No additional storage space is needed, since the cabinets can be neatly put together

Push-Drawers

* For condiments and accessories

The high quality paint and furniture lacquer finish, make them stunning displays in your foyer, and they do not need any additional storage space.



Non-marring Casters

* Allows easy changing and relocating of the setups



GO2AA - IOMO1

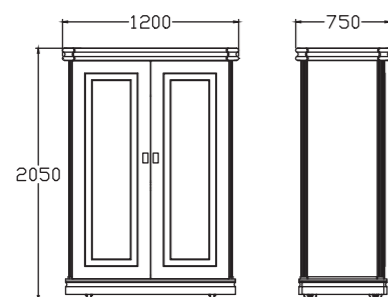

Customized Setups

* besides our standard functions, we can also make changes according your needs



Build-in Power Sockets

– allow you to plug in your coffee machine, mini fridges and tea urns

GO2AA - IOMO2

► **Door Options** – let us know what you want to setup inside the doors, so we can make changes accordingly

► **Customized Setups** – besides our standard functions, we can also make changes according your needs

► **Designer Pattern** – with the vast choice of finishing and patterns, we can give the cabinet a signature to match your interior design



* Customized Panels

北京西科盛世通酒店会展设备制造有限公司

BEIJING SICO-SST HOSPITALITY EQUIPMENT MANUFACTURING CO.,LTD

分公司:

扬州西科盛世通智能设备制造有限公司

YANGZHOU SICO-SST HI-TECH INVENTION MANUFACTURING CO.,LTD

Tel: 4008188058

www.sico-sst.com.cn www.sicoinc.com

No.8, Anqing Street, Zone B, Tianzhu Airport Industrial Zone

Shunyi District, Beijing, China

101312